

mectron

→ MECTRON
PIEZOSURGERY® INSERTS



PIEZOSURGERY®

PIEZOSURGERY® THE ORIGINAL
PIEZOELECTRIC
BONE SURGERY —
EVIDENCE-BASED!



4	PIEZOSURGERY® Technique	35	Insert IM3.4P	62	Insert PL0631	89	Insert EN6L
6	Insert quality	36	Insert IM4A	63	Insert PL0719	90	Insert EX1
8	Indications	37	Insert IM4P	64	Insert OP1	91	Inserts EX2 - EX3
10	Basic Set	38	Insert P2-3	65	Insert OP2	92	Piezoelectric levers
11	Osteotomy Set	39	Insert P3-4	66	Inserts OP3 - OP3A	93	Insert EXL1
12	Sinus Lift Lateral Set	40	Inserts OT1 - OT1A	67	Insert OP4	94	Insert EXL2
13	Piezo Lift Set	41	Insert OT2	68	Inserts OP5 - OP5A	95	Insert EXL3
14	Manual Piezo Lift Set	42	Insert OT4	69	Insert OP6	96	Inserts EXP3-R - EXP3-L
15	Sinus Lift Set	43	Inserts OT5 - OT5A - OT5B	70	Insert OP7	97	Inserts EXP4-R - EXP4-L
16	Implant Prep Set Pro	44	Insert OT6	71	Insert OP8	98	Insert PS1
17	Extraction Set	45	Inserts OT7 - OT7A	72	Insert OP9	99	Insert PS2
18	Third Molar Extraction Set	46	Insert OT7S-4	73	Insert SLC	100	Insert PS6
19	Explantation Set	47	Insert OT7S-3	74	Insert EL1	101	Insert PP1
20	Resective Perio Set	48	Insert OT7-20	75	Insert EL2	102	Insert PP10
21	Retro Surgical Set	49	Inserts OT8R - OT8L	76	Insert EL3	103	Inserts PP11-PP12
22	Insert box and Insert tray	50	Insert OT9	77	Insert SLS	104	Tipholder ICP, tip IC1
24	Insert IM1S	51	Insert OT11	78	Insert SLE1	105	Crown prep tips
25	PINS IM1, IM1S, 2-2.4, 2-3	52	Insert OT12	79	Insert SLE2	106	Enzymec
26	Insert IM1 AL	53	Insert OT12S	80	Insert PR1	108	Science
27	PINS IM1 AL, 2-2.4 AL, 2-3 AL	54	Insert OT13	81	Insert PR2	109	Mectron education
28	Inserts IM2A - IM2A-15	55	Insert OT14	82	Insert EN1	110	Spare Parts
29	Inserts IM2P - IM2P-15	56	Insert SLO-H	83	Insert EN2	112	Reference Numbers
30	Insert IM2.8A	57	Insert PL1	84	Insert EN3	114	Appropriate settings for the inserts
31	Insert IM2.8P	58	Insert PL2	85	Insert EN4	118	Implant site preparation sequence
32	Inserts IM3A - IM3A-15	59	Insert PL3	86	Insert EN5R		
33	Inserts IM3P - IM3P-15	60	Insert PL0419	87	Insert EN5L		
34	Insert IM3.4A	61	Insert PL0527	88	Insert EN6R		

→ PIEZOSURGERY® TECHNIQUE

→ PIEZOSURGERY®
HAS DEFINED A
NEW DIMENSION
IN BONE SURGERY



- It's simple, stress-free and selective
- It increases the quality and success for you and your patients



Thanks to the controlled sophisticated ultrasound vibrations, the original PIEZOSURGERY® technique opens up a new age for osteotomy, osteoplasty and extraction in Implantology, Periodontology, Endodontics and Surgical Orthodontics.

- MICROMETRIC CUTS: optimal surgical precision and intra-operative sensitivity
- SELECTIVE CUTS: minimal damage to soft tissue, offering safety for you and your patients
- CAVITATION EFFECT: optimal intra-operative visibility and a blood-free surgical site
- HISTOLOGICAL ADVANTAGE: more favorable bone healing in osseointegration process

→ INSERT QUALITY



→ PRECISION

A CNC controlled 5-dimensional sharpening machine cuts with an accuracy of up to 0.01 mm. The whole cutting process for a single insert last up to 12 min.

→ MATERIAL

mectron ultrasound inserts are built with medical grade, high quality, stainless steel.



→ HIGH END INSERTS FOR PROFESSIONALS

Each mectron ultrasound insert will pass through 12 working steps.



→ DIAMOND COATING

Depending on the indication, the inserts are coated with specially selected diamonds. The granulometry of the diamond coating is adapted to the respective treatment.



→ TITANIUM NITRIDE COATING

A coating of titanium nitride, applied to inserts which treat bone, increases the hardness of the surface, avoids corrosion and therefore increases working life.



→ LABELING

Each insert is gently labeled by a laser.

→ QUALITY CHECK

Each insert is checked in detail before getting an OK for the sales.

INDICATIONS

→ SINUS LIFT TECHNIQUE CRESTAL APPROACH	→ SINUS LIFT TECHNIQUE LATERAL APPROACH	→ IMPLANT SITE PREPARATION	→ RIDGE EXPANSION	→ PERIOSTEUM PREPARATION	→ EXTRACTIONS	→ THIRD MOLAR EXTRACTION	→ EXPLANTATION
→ PIEZO-LIFT	→ STANDARD	→ STANDARD	→ OPTIONAL	→ STANDARD	→ STANDARD	→ STANDARD	→ STANDARD
PL1	SLC	IM1S	IM1 AL	OT7	PR1	EX1	EXP3-R
PL2	SLO-H	IM2A	IM2A-15	OT4	PR2	EX2	EXP3-L
PL3	SLS	IM3A	IM2.8A	OP5		EX3	EXP4-R
PL0419	SLE1	IM4A	IM3A-15	OT12	PS2	→ OPTIONAL	EXP4-L
PL0527	SLE2	IM2P	IM3.4A	→ OPTIONAL		EX1	
PL0631	OP3	IM3P	IM2P-15	OT2		SLO-H	
PL0719	OT1	IM4P	IM2.8P	OT7A			
	EL1	OT4	IM3P-15	OT7S-4			
	→ OPTIONAL	P2-3	IM3.4P	OT7S-3			
	OT1A	P3-4	PIN IM1	OT7-20			
	OT5		PIN 2-2.4	OT12S			
	OT5A						
	OT5B						
	EL2						
	EL3						

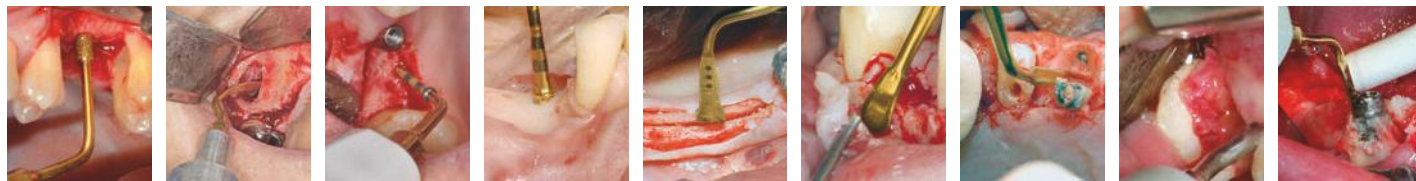

→ BONE BLOCK GRAFTING	→ BONE CHIP GRAFTING/BONE MODELING	→ ENDODONTICS	→ OSTEOTOMY CLOSE TO NERVES	→ CORTICOTOMY TECHNIQUE	→ PERIODONTAL SURGERY	→ CROWN PREPARATION
→ STANDARD	→ STANDARD	→ STANDARD	→ STANDARD	→ STANDARD	→ STANDARD	→ OPTIONAL
OT7	OP3	OP7	OT1	OT7S-4	OP5A	PS1
OP5	OP1	PS2	OT5	OT7S-3	OP8	PS6
OT8L	→ OPTIONAL	EN1		→ OPTIONAL	OP9	PP10
OT8R	OP2	EN2		OT7	OT13	PP11
OT12	OP3A	EN3		OT7A	OT14	PP12
→ OPTIONAL		EN4			OP5	OP2
OT6		→ OPTIONAL			OP3	OP3A
OT7A		EN5R			PS2	OP4
OT7S-4		EN5L			PP1	OP6
OT7S-3		EN6R			ICP + IC1	
OT7-20		EN6L				
OT12S		OP3				
						DB2
						CROWN PREP TIPS
						TA12D90* Ø 1.2 mm
						TA12D60*
						TA14D120* Ø 1.4 mm
						TA14D90*
						TA14D60*
						TA16D120* Ø 1.6 mm
						TA16D90*
						TA16D60*
						TF12D90* Ø 1.2 mm
						TF12D60*
						TF16D90* Ø 1.6 mm
						TF16D60*

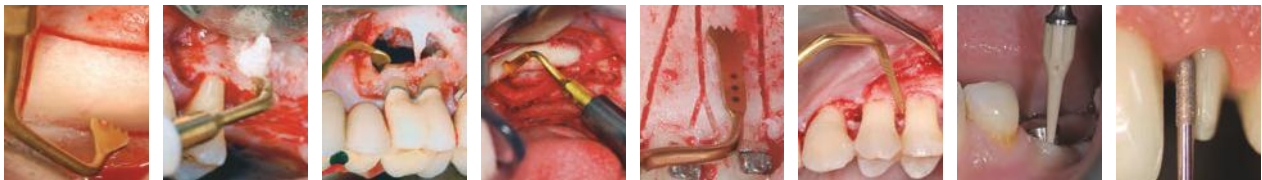

→ BASIC SET

→ EQUIPPED WITH:

- 1 insert OT7
- 1 insert OT2
- 1 insert EX1
- 1 insert OP1
- 1 insert OP3
- 1 insert tray

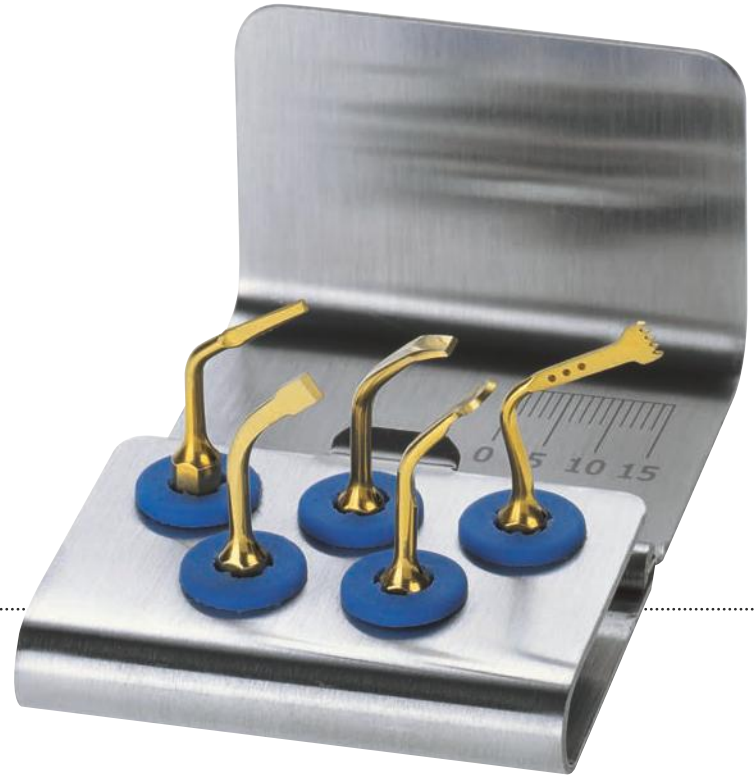

→ OT7 → OT2 → EX1 → OP1 → OP3



→ OSTEOTOMY SET



→ EQUIPPED WITH:

- 1 insert OT7
- 1 insert OT7S-4
- 1 insert OT7S-3
- 1 insert OT8R
- 1 insert OT8L
- 1 insert tray

→ OT7 → OT7S-4 → OT7S-3 → OT8R → OT8L

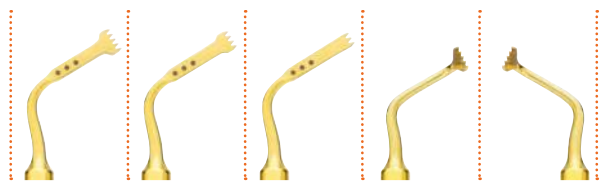

→ SINUS LIFT LATERAL SET*

→ EQUIPPED WITH:

- 1 insert SLC
- 1 insert SLO-H
- 1 insert SLS
- 1 insert SLE1
- 1 insert SLE2
- 1 insert tray

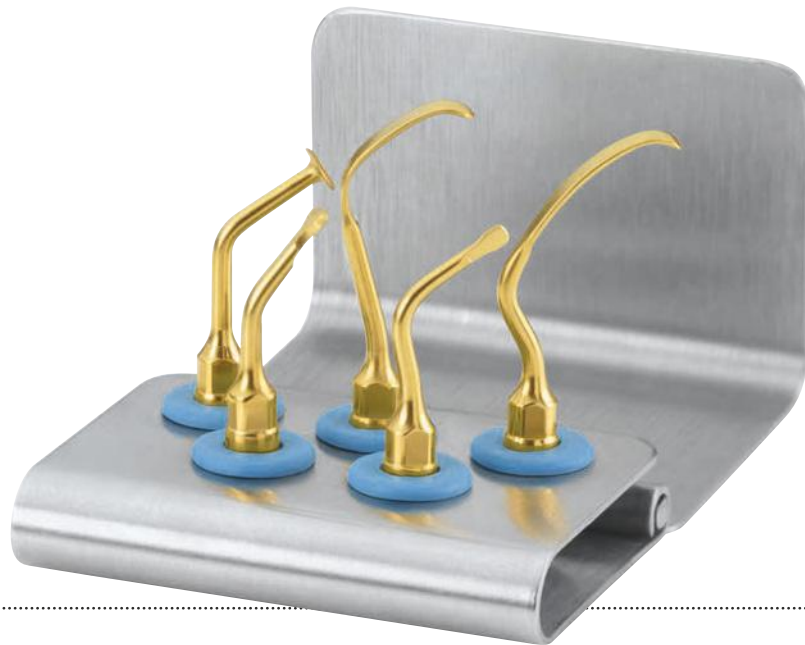

→ SLC → SLO-H → SLS → SLE1 → SLE2



→ PIEZO LIFT SET*



→ EQUIPPED WITH:

- 1 insert PL1
- 1 insert PL2
- 1 insert PL3
- 1 insert tray

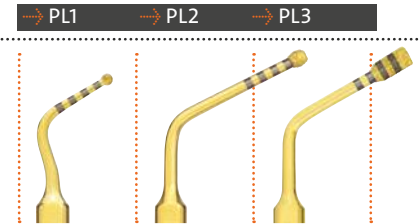

→ MANUAL PIEZO LIFT SET*

→ EQUIPPED WITH:

- 1 insert PL0419
- 1 insert PL0527
- 1 insert PL0631
- 1 insert PL0719
- 1 insert tray



→ PL0419 → PL0527 → PL0631 → PL0719

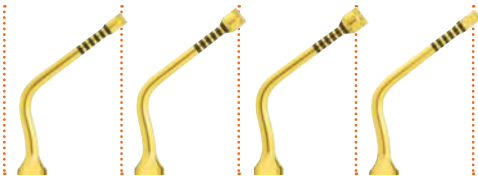

→ SINUS LIFT SET*

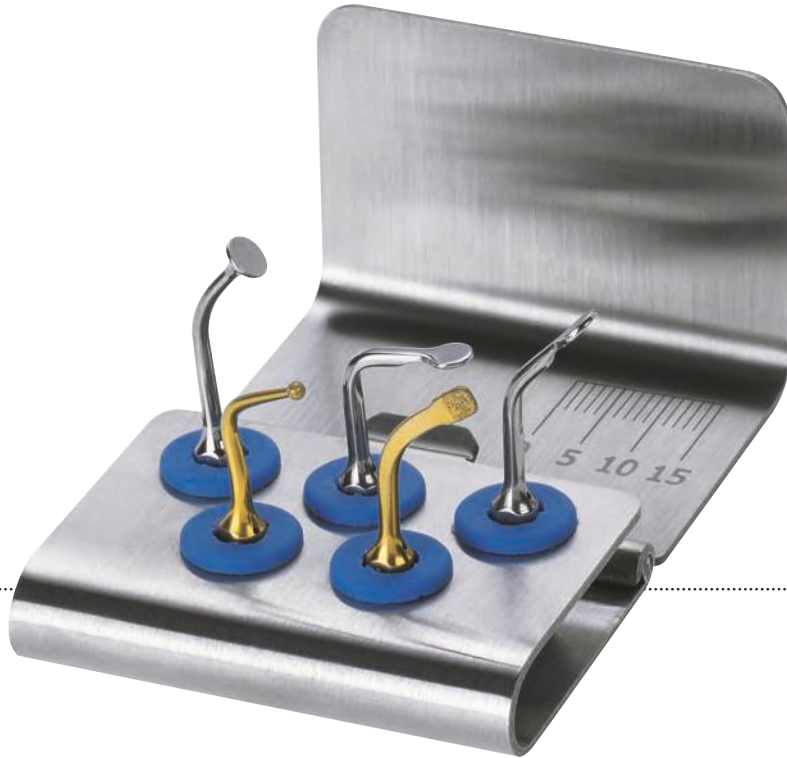

→ EQUIPPED WITH:

- 1 insert OT1
- 1 insert OT5
- 1 insert EL1
- 1 insert EL2
- 1 insert EL3
- 1 insert tray

→ OT1 → OT5 → EL1 → EL2 → EL3



* developed in collaboration with Prof. Tomaso Vercellotti

→ IMPLANT PREP SET PRO*

→ EQUIPPED WITH:

- 1 insert IM1S
- 1 insert IM2A
- 1 insert IM2P
- 1 insert IM3A
- 1 insert IM3P
- 1 insert OT4
- 1 insert IM4A
- 1 insert IM4P
- 1 insert P2-3
- 1 insert P3-4
- 3 pins IM1S
- 3 pins 2-2.4
- 1 implant insert tray



→ IM1S → IM2A → IM2P → IM3A → IM3P → OT4 → IM4A → IM4P → P2-3 → P3-4 → PIN IM1S → PIN 2-2.4

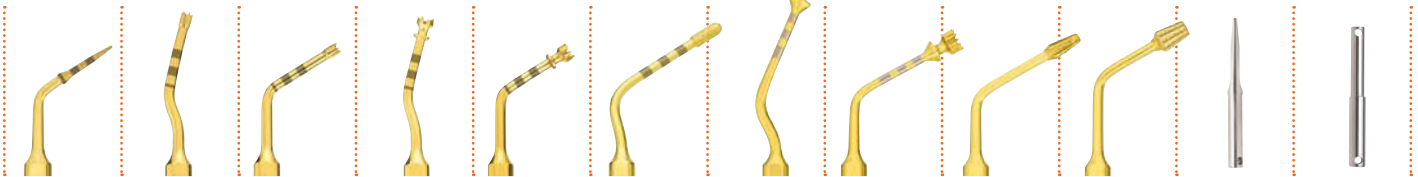

→ EXTRACTION SET*



→ EQUIPPED WITH:

- 1 insert EX1
- 1 insert EX2
- 1 insert EX3
- 1 insert PS2
- 1 insert PS6
- 1 insert tray

→ EX1 → EX2 → EX3 → PS2 → PS6

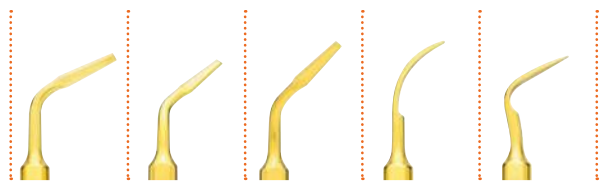

* developed in collaboration with Prof. Tomaso Vercellotti

→ THIRD MOLAR EXTRACTION SET*

→ EQUIPPED WITH:

- 1 lever EXL1
- 1 lever EXL2
- 1 lever EXL3
- 1 insert EX1
- 1 insert SLO-H
- 1 insert tray

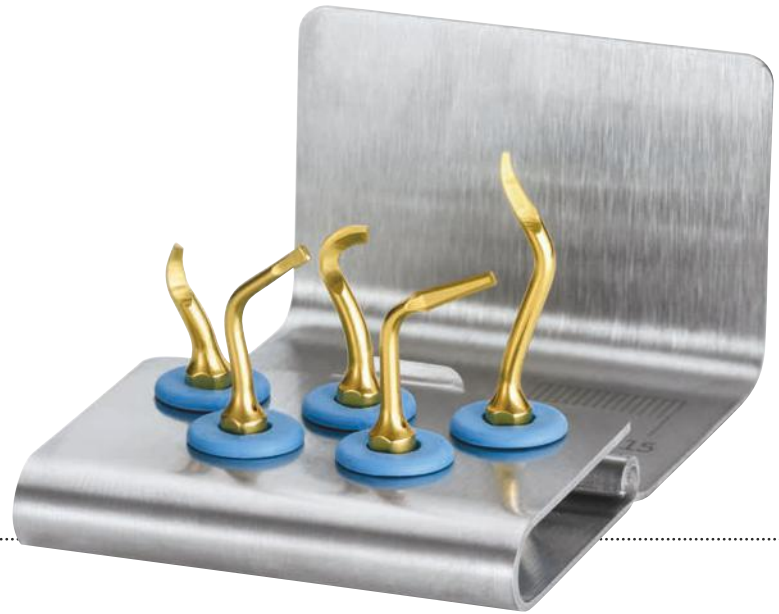

→ EXL1 → EXL2 → EXL3 → EX1 → SLO-H

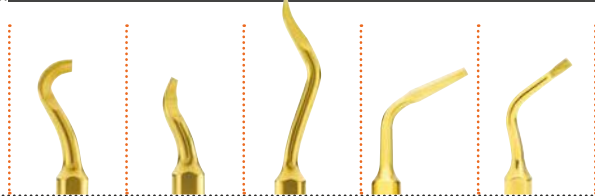

→ EXPLANTATION SET



→ EQUIPPED WITH:

- 1 insert EXP3-R
- 1 insert EXP3-L
- 1 insert EXP4-R
- 1 insert EXP4-L
- 1 insert tray

→ EXP3-R → EXP3-L → EXP4-R → EXP4-L

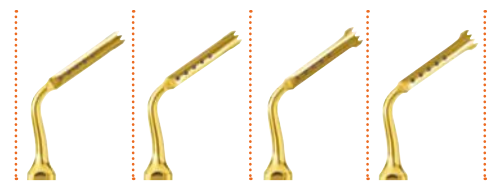

RESECTIVE PERIO SET*

→ EQUIPPED WITH:

- 1 insert OT13
- 1 insert OT14
- 1 insert OP5A
- 1 insert OP8
- 1 insert OP9
- 1 insert tray

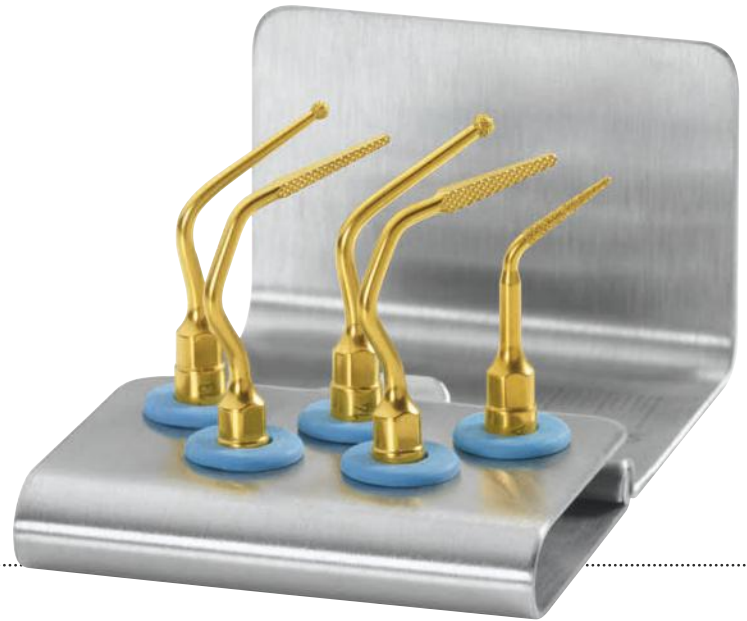

→ OT13 → OT14 → OP5A → OP8 → OP9

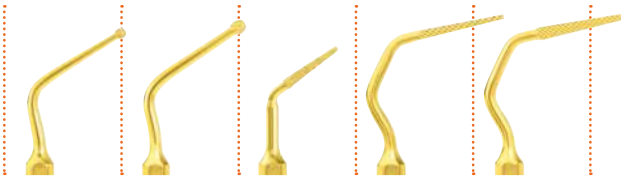

→ RETRO SURGICAL SET



→ EQUIPPED WITH:

- 1 insert OP7
- 1 insert EN1
- 1 insert EN3
- 1 insert EN5R
- 1 insert EN5L
- 1 insert tray

→ OP7 → EN1 → EN3 → EN5R → EN5L

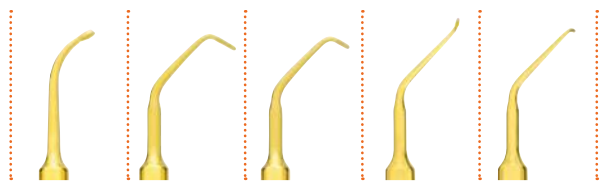

→ INSERT BOX AND TRAY PIEZOSURGERY®



→ INSERT BOX

- box fully autoclavable
- perfect storage of all PIEZOSURGERY® inserts
- light, easy to use, compact and roomy

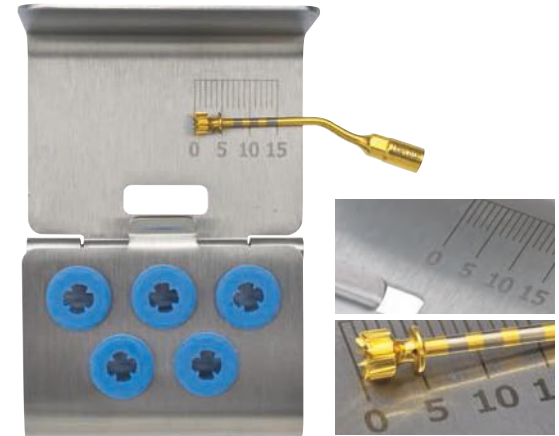

→ INSERT TRAY

- stainless steel tray with depth markings
- ideal for storage
- tray fully autoclavable

→ CUTTING ACTION
bone perforation

→ CLINICAL APPLICATION
initial pilot osteotomy

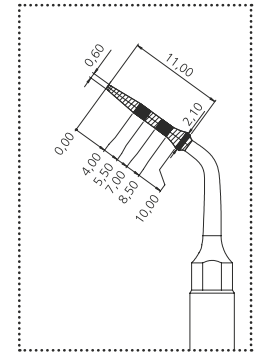
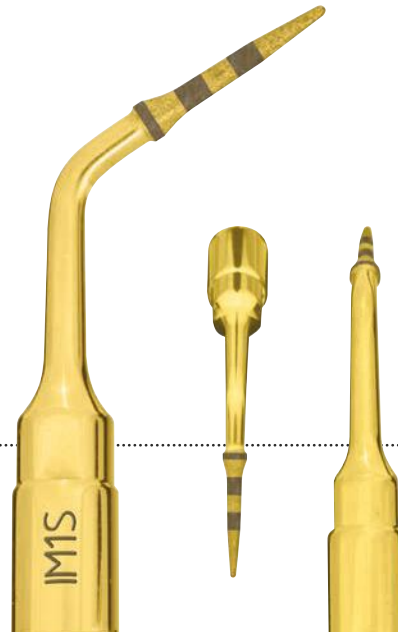

diamond grain size 30 µm

→ PINS IM1, IM1S, 2-2.4, 2-3

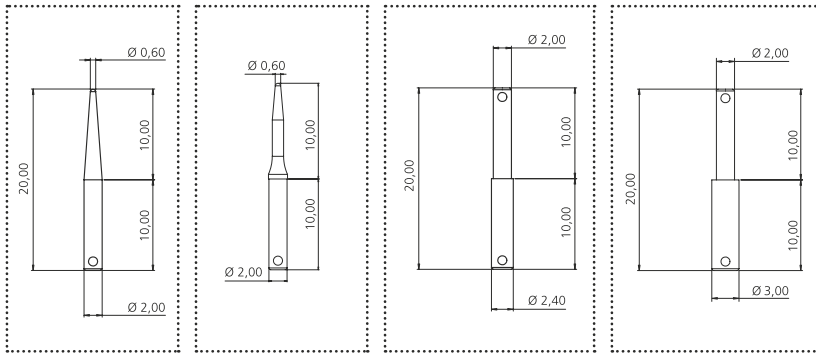

→ DESCRIPTION

alignment pins, dedicated to IM1S, IM2 ($\varnothing 2$), IM3 ($\varnothing 3$), OT4 ($\varnothing 2.4$), IM1 SP

→ CLINICAL APPLICATION

to check preparation axis alignment

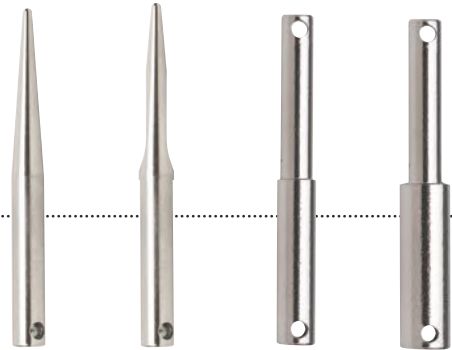

→ PIN IM1

→ PIN IM1S

→ PIN 2-2.4

→ PIN 2-3

IM1 AL

insert for initial osteotomy in extraction sites

→ CUTTING ACTION

bone perforation

→ CLINICAL APPLICATION

initial pilot osteotomy in extraction sites

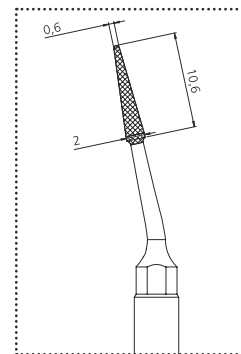
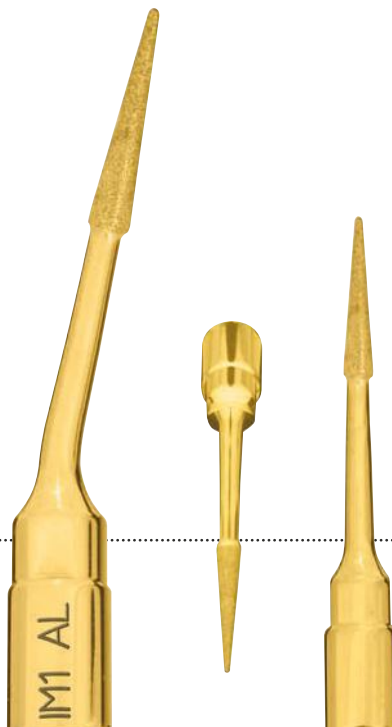

diamond grain size 30 μ m

→ ALVEOLAR PINS IM1 AL, 2-2.4 AL, 2-3 AL

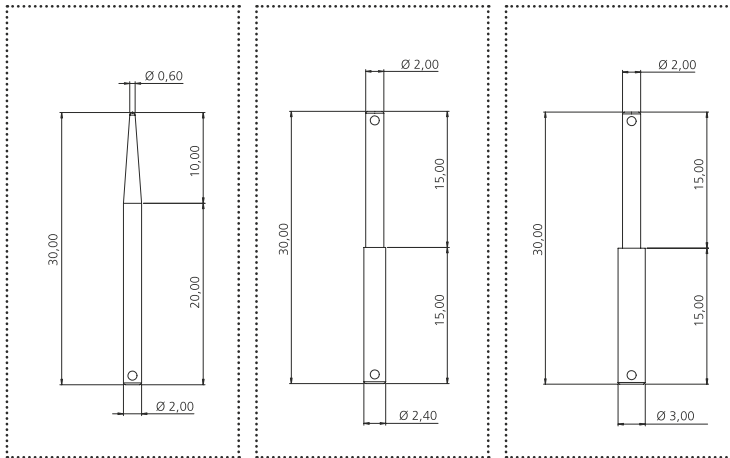

→ DESCRIPTION

30 mm alignment pins, for extraction sites dedicated to IM1 AL, IM2A ($\varnothing 2$), OT4 ($\varnothing 2.4$), IM3A ($\varnothing 3$)

→ CLINICAL APPLICATION

to check preparation axis alignment



→ PIN IM1 AL

→ PIN 2-2.4 AL

→ PIN 2-3 AL

→ IM2A – IM2A-15

2 mm Ø implant site preparation insert

→ CUTTING ACTION
bone perforation

→ CLINICAL APPLICATION
pilot osteotomy in anterior region

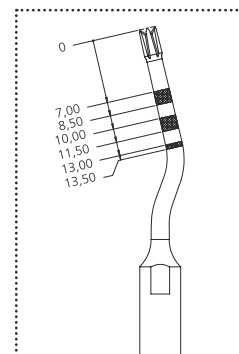

2 mm Ø implant site preparation insert

IM2P – IM2P-15

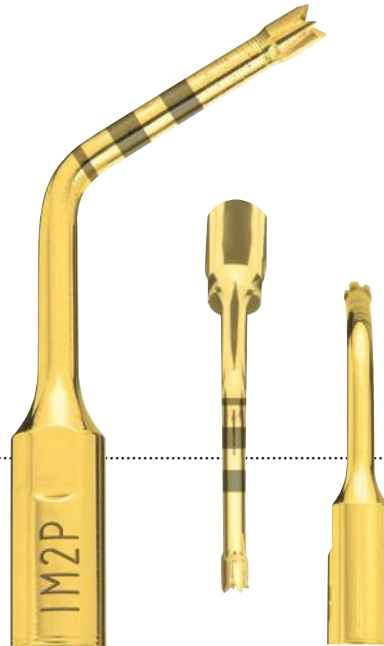
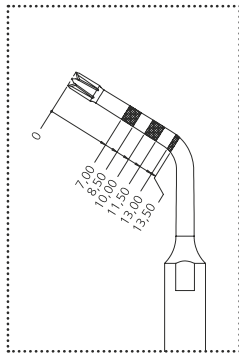

→ CUTTING ACTION
bone perforation

→ CLINICAL APPLICATION
pilot osteotomy in posterior region



IM2.8A

2.8 mm \emptyset implant site preparation insert

→ CUTTING ACTION

bone perforation

→ CLINICAL APPLICATION

to enlarge or to finalize the implant site preparation; insert with double irrigation to avoid overheating

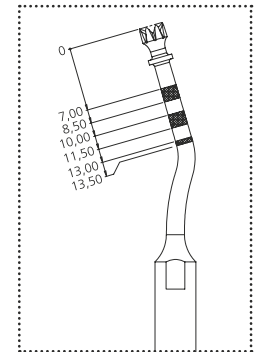

2.8 mm \varnothing implant site preparation insert

IM2.8P

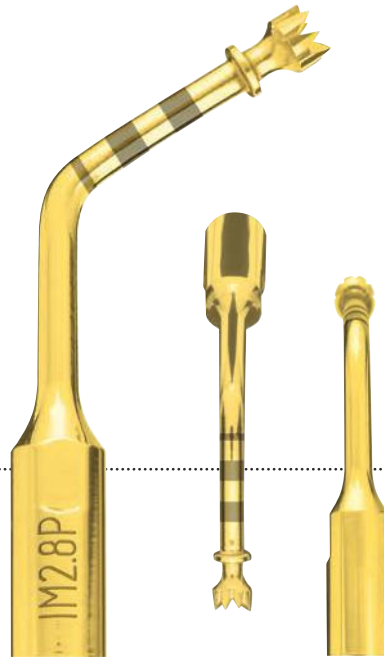
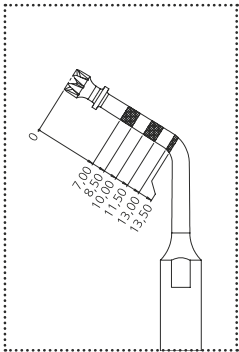

→ CUTTING ACTION

bone perforation

→ CLINICAL APPLICATION

to enlarge or to finalize the implant site preparation; insert with double irrigation to avoid overheating



IM3A – IM3A-15

3 mm Ø implant site preparation insert

→ CUTTING ACTION

bone perforation

→ CLINICAL APPLICATION

to enlarge or to finalize the implant site preparation; insert with double irrigation to avoid overheating

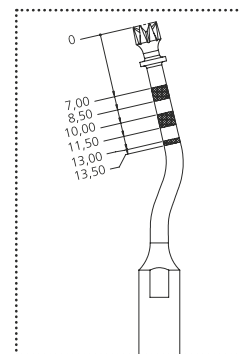

3 mm Ø implant site preparation insert

→ IM3P – IM3P-15

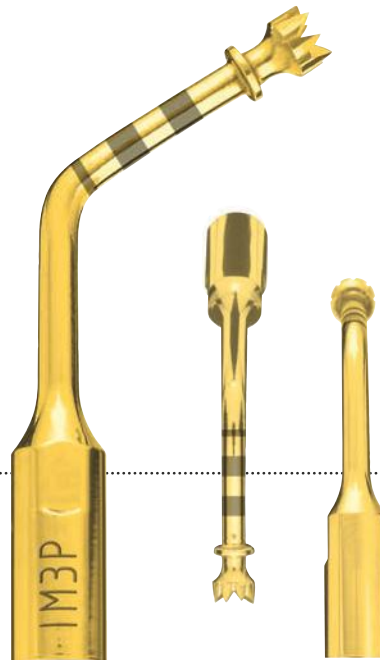
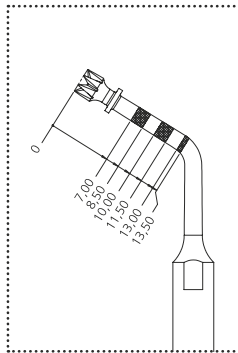

→ CUTTING ACTION
bone perforation

→ CLINICAL APPLICATION
to enlarge or to finalize the implant
site preparation; insert with double
irrigation to avoid overheating

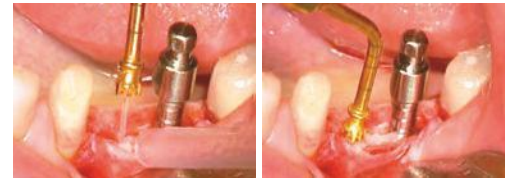

→ **CUTTING ACTION**

bone perforation

→ **CLINICAL APPLICATION**

to enlarge or to finalize the implant site preparation; insert with double irrigation to avoid overheating

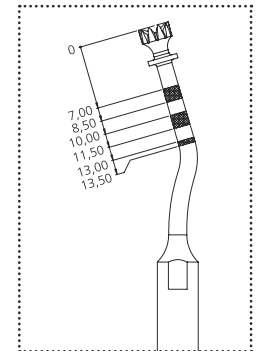

3.4 mm Ø implant site preparation insert

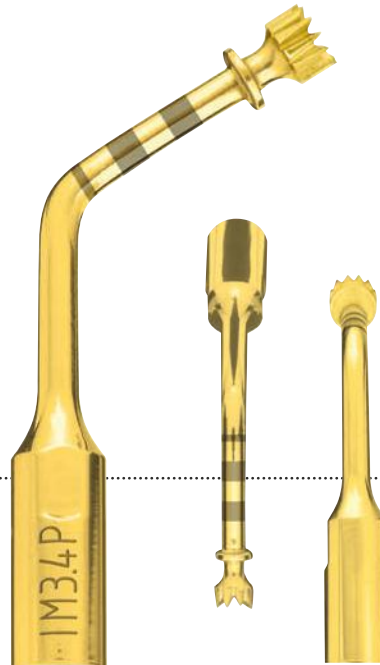
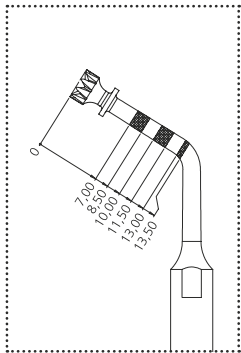

→ CUTTING ACTION

bone perforation

→ CLINICAL APPLICATION

to enlarge or to finalize the implant site preparation; insert with double irrigation to avoid overheating

→ CUTTING ACTION
bone perforation

→ CLINICAL APPLICATION
to finalize the implant site
preparation; insert with double
irrigation to avoid overheating

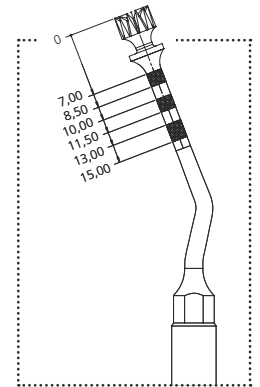

4 mm Ø implant site preparation insert

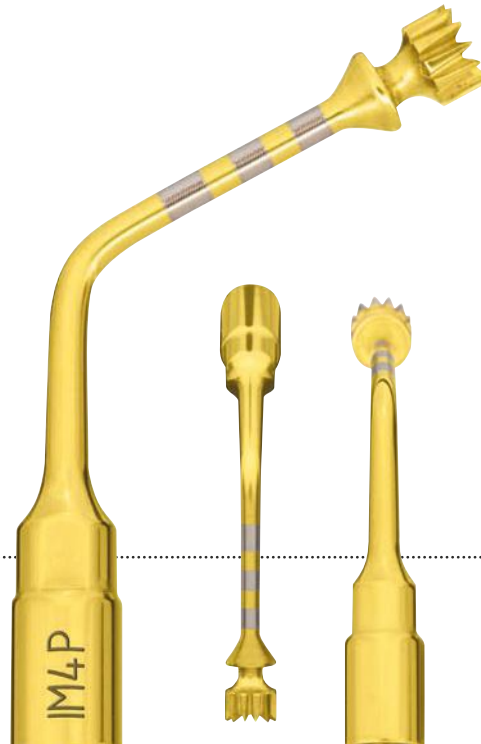
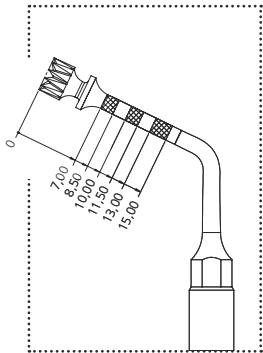

→ CUTTING ACTION
bone perforation

→ CLINICAL APPLICATION
to finalize the implant site
preparation; insert with double
irrigation to avoid overheating



→ CUTTING ACTION
micrometric osteotomy

→ CLINICAL APPLICATION
to optimize concentricity of
implant site preparation
between $\varnothing 2$ and $\varnothing 3$ mm

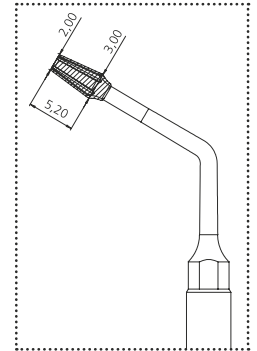
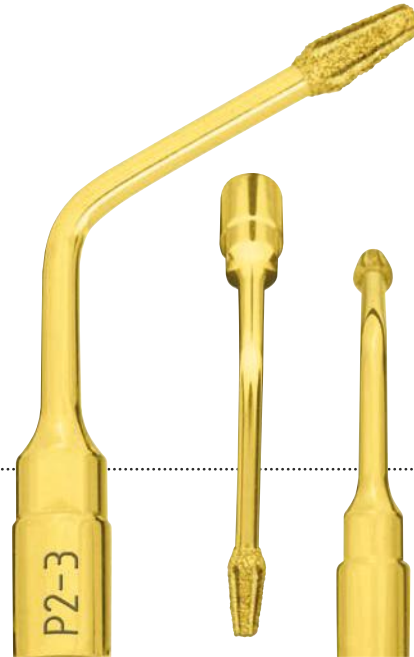

diamond grain size 150 μm

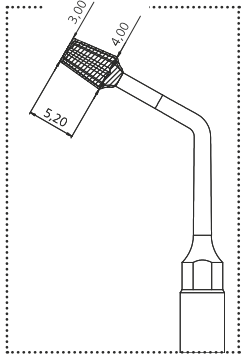

diamond grain size 150 µm

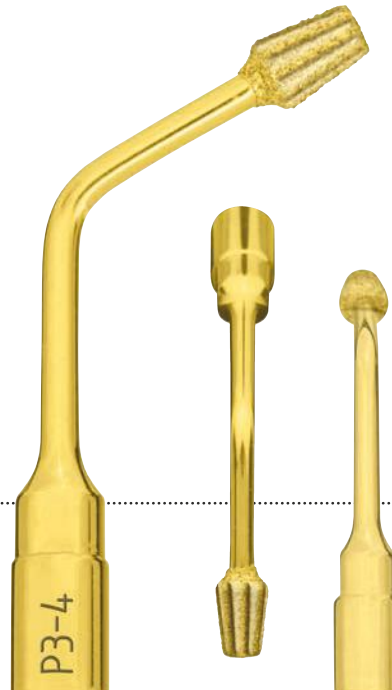

→ **CUTTING ACTION**
micrometric osteotomy

→ **CLINICAL APPLICATION**
to optimize concentricity of
implant site preparation
between $\varnothing 3$ and $\varnothing 4$ mm



→ OT1 – OT1A

sinus bony window osteotomy insert

→ CUTTING ACTION

micrometric osteotomy (about 1 mm)

→ CLINICAL APPLICATION

to finalize the osteotomy in proximity of soft tissue (for example: sinus membrane, vessel, alveolar nerve)

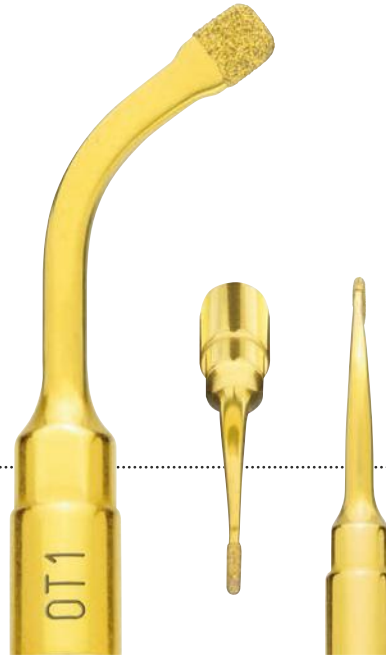

diamond grain size 126 μm

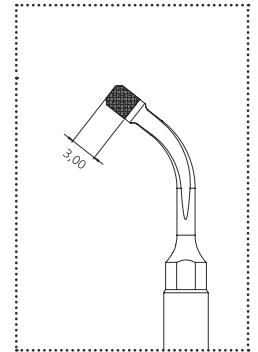

diamond grain size 91 μm

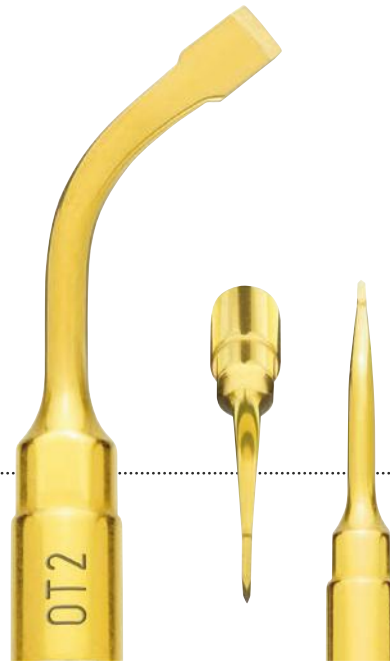

→ CUTTING ACTION
osteotomy

→ CLINICAL APPLICATION
osteotome of great precision
in anatomically thin structures
(for example, ridge expansion,
interdental corticotomies)

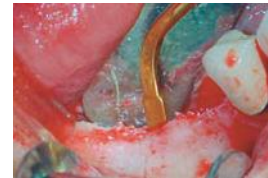

→ **CUTTING ACTION**
micrometric osteotomy (about 1 mm)

→ **CLINICAL APPLICATION**
to correct pilot osteotomy axis, to
finalize the implant site preparation
close to the alveolar nerve; sinus
crestal approach technique

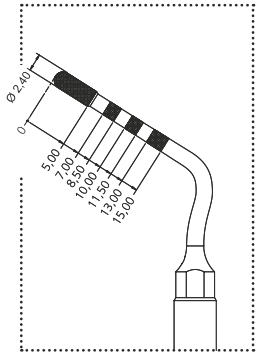

diamond grain size 151 µm

osteoplasty and osteotomy insert

→ OT5 – OT5A – OT5B



→ CUTTING ACTION
micrometric osteotomy or osteoplasty

→ CLINICAL APPLICATION
non-traumatic, to finalize the osteotomy or osteoplasty on thin bone and/or near delicate anatomic structures

Ø 1.7 – diamond grain size 91 µm

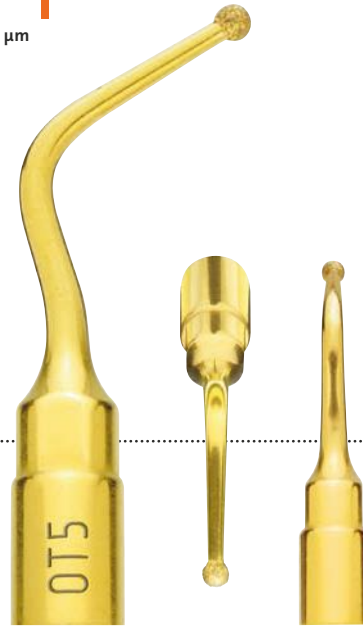

→ CUTTING ACTION

high effectiveness osteotomy

→ CLINICAL APPLICATION

osteotomy of large bone sections
during maxillofacial surgery



principal micro-saw 0.55 mm

→ OT7 – OT7A

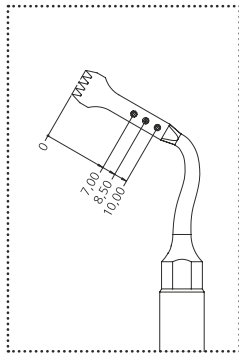

thickness 0.55 mm



→ **CUTTING ACTION**
high effectiveness osteotomy

→ **CLINICAL APPLICATION**
all the osteotomy technique
in maxilla and mandible

- ridge expansion
- corticotomy technique
- bone block grafting



→ OT7S-4

special micro-saw 0.35 mm (4 teeth)

→ CUTTING ACTION

high effectiveness and precision
osteotomy

→ CLINICAL APPLICATION

very thin osteotomy, corticotomy for
orthodontic microsurgery technique,
root separation in dental extraction
technique and periodontal surgery

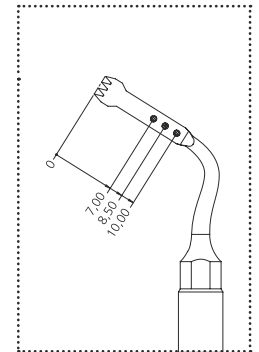

special micro-saw 0.35 mm (3 teeth)

→ OT7S-3

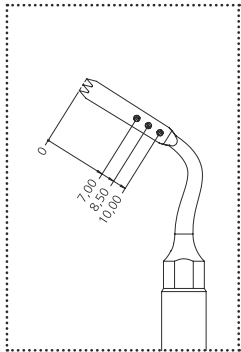

→ CUTTING ACTION

high precision osteotomy

→ CLINICAL APPLICATION

very thin and small osteotomy
and corticotomy technique for
orthodontic microsurgery, root
fraction technique for dental
extraction maneuver



OT7-20

micro-saw, length 20 mm

→ CUTTING ACTION

high effectiveness osteotomy

→ CLINICAL APPLICATION

ridge expansion technique, bone block grafting (from chin/mandible ramus), Le Fort I osteotomy, bilateral sagittal split osteotomy



tight up this insert only
with torque wrench K8



thickness 0.6 mm

angled micro-saw 0.6 mm

→ OT8R – OT8L

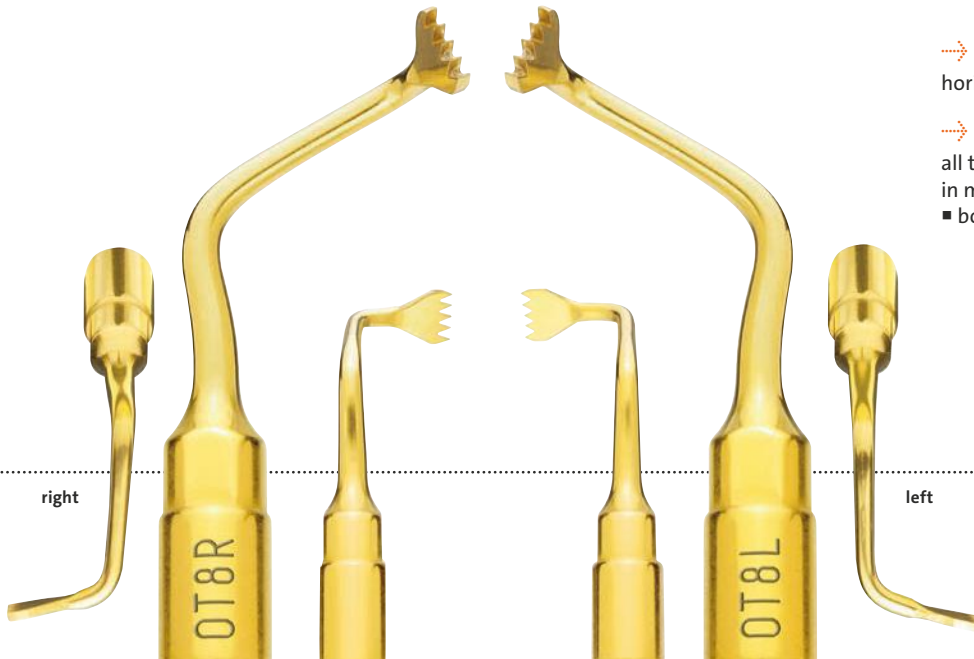

→ CUTTING ACTION

horizontal osteotomy

→ CLINICAL APPLICATION

all the osteotomy technique

in maxilla and mandible

■ bone block grafting



→ CUTTING ACTION

micrometric osteotomy or osteoplasty

→ CLINICAL APPLICATION

to finalize the osteotomy or osteoplasty near delicate anatomic structures;
insert with double irrigation to avoid overheating

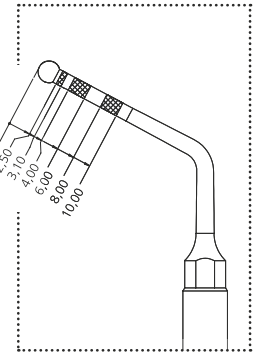

Ø 2.4 – diamond grain size 151 µm

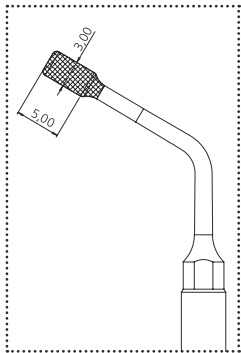

Ø 3.0 – diamond grain size 151 µm



→ CUTTING ACTION

micrometric osteotomy or osteoplasty

→ CLINICAL APPLICATION

removal of the sinus basal cortex and elevation of the sinus membrane



→ OT12

circular micro-saw 0.35 mm

→ CUTTING ACTION

high effectiveness and precision osteotomy

→ CLINICAL APPLICATION

dedicated to the osteotomy techniques where the standard piezoelectric bone saws may have a difficult surgical approach

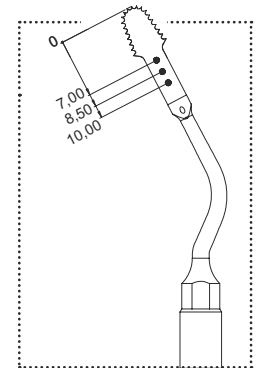

circular micro-saw 0.25 mm

OT12S

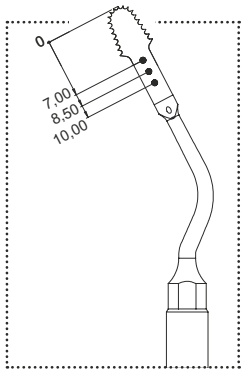

→ CUTTING ACTION

high effectiveness and precision
osteotomy

→ CLINICAL APPLICATION

dedicated to the osteotomy
techniques where the standard
piezoelectric bone saws may have
a difficult surgical approach

→ CUTTING ACTION

micrometric osteotomy or osteoplasty

→ CLINICAL APPLICATION

non-traumatic bone defect preparation
in resective periodontal surgery

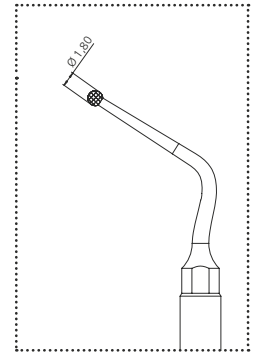

Ø 1.8 – diamond grain size 150 µm

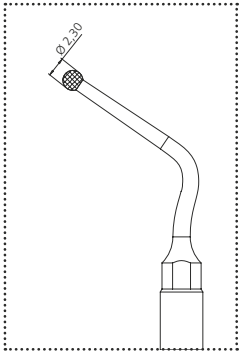

Ø 2.3 – diamond grain size 150 µm



→ CUTTING ACTION

micrometric osteotomy or osteoplasty

→ CLINICAL APPLICATION

non-traumatic bone defect preparation
in resective periodontal surgery



→ CUTTING ACTION

high precision osteotomy

→ CLINICAL APPLICATION

to finalize the bone window osteotomy
to gain access to the sinus membrane

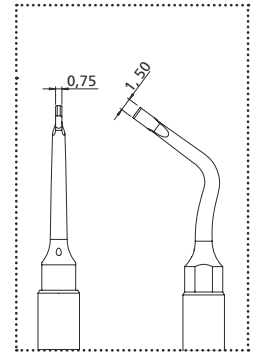

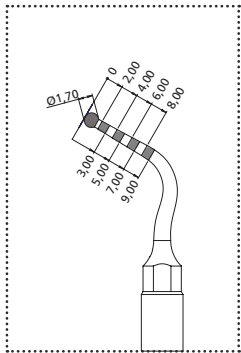

→ CUTTING ACTION

micrometric osteotomy or osteoplasty

→ CLINICAL APPLICATION

sinus floor reaching and safe bony ring removal during crestal sinus lift procedure (PIEZO-LIFT)



→ CUTTING ACTION

micrometric osteotomy or osteoplasty

→ CLINICAL APPLICATION

sinus floor consumption and initial membrane elevation during crestal sinus lift procedure (PIEZO-LIFT)

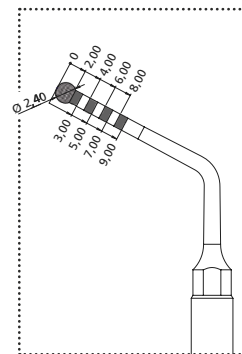
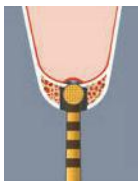

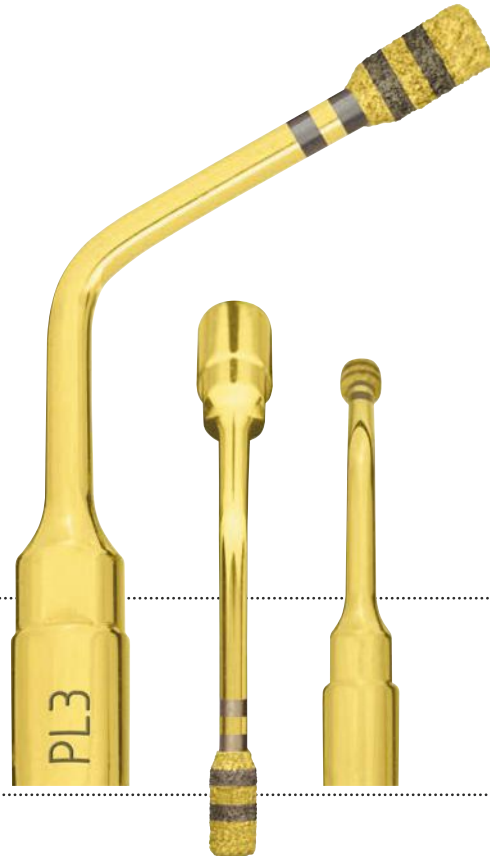
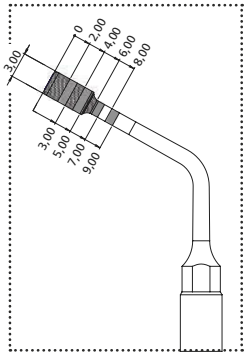

→ CUTTING ACTION

micrometric osteotomy or osteoplasty

→ CLINICAL APPLICATION

removal of the sinus basal cortex and elevation of the sinus membrane during crestal sinus lift procedure (PIEZO-LIFT)



→ **CUTTING ACTION**

micrometric osteotomy or osteoplasty

→ **CLINICAL APPLICATION**

sinus floor removal and membrane detachment during Manual Piezo Lift technique ($\text{\textcircled{D}} = 1.9 \text{ mm}$)

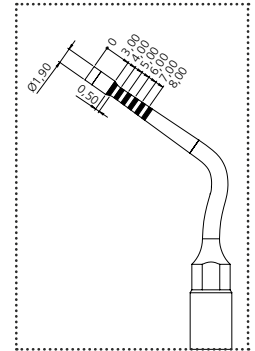
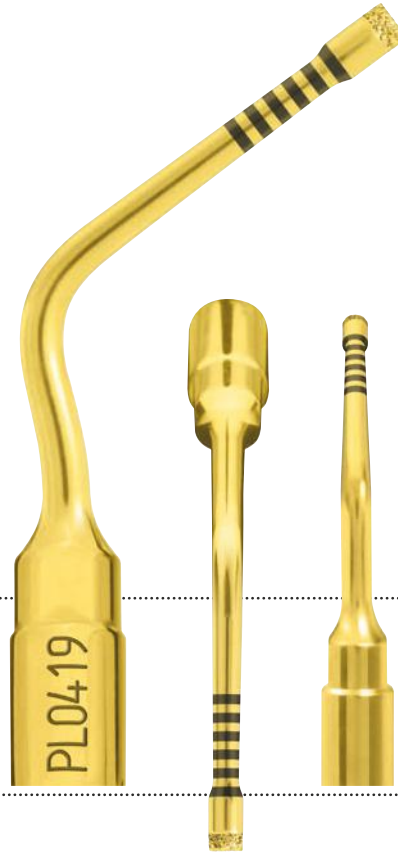
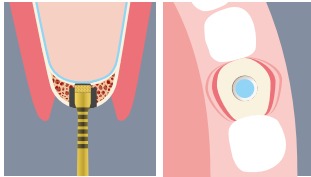

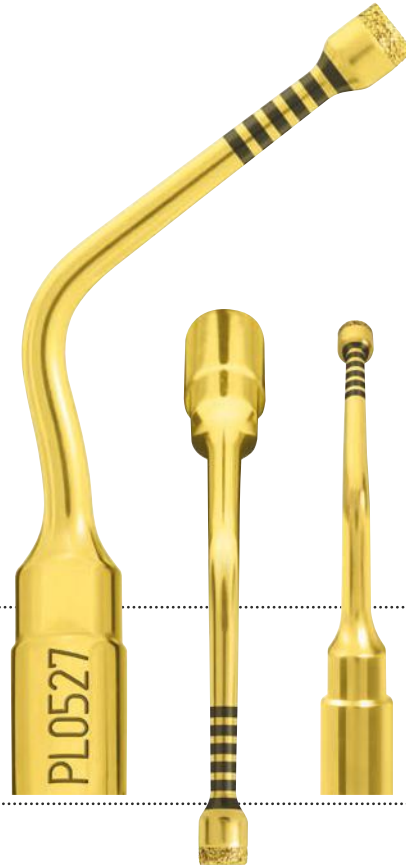
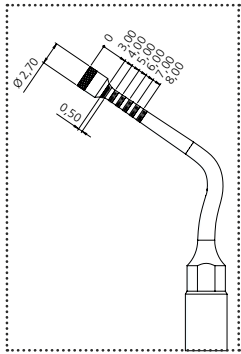

→ CUTTING ACTION

micrometric osteotomy or osteoplasty

→ CLINICAL APPLICATION

sinus floor removal and membrane detachment during Manual Piezo Lift technique ($\varnothing = 2.7$ mm)

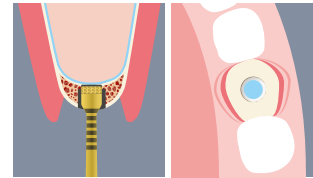

→ CUTTING ACTION

micrometric osteotomy or osteoplasty

→ CLINICAL APPLICATION

sinus floor removal and membrane detachment during Manual Piezo Lift technique ($\varnothing = 3.1 \text{ mm}$)

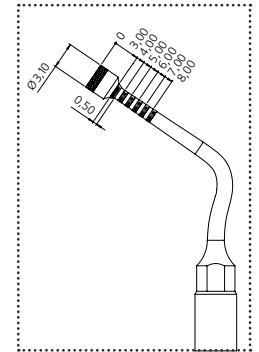
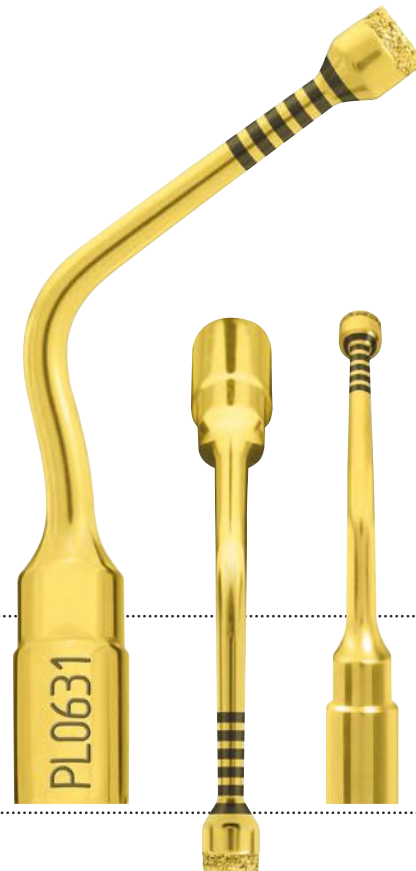
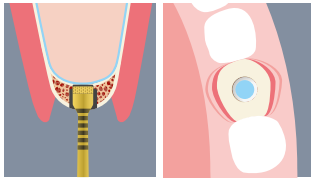

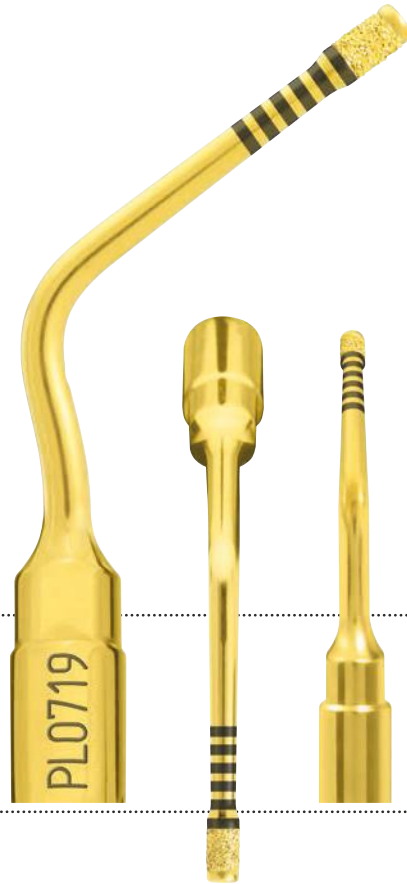
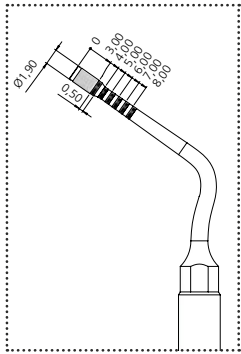

→ CUTTING ACTION

micrometric osteotomy or osteoplasty

→ CLINICAL APPLICATION

removal of the safety bone ring during Manual Piezo Lift technique ($\varnothing = 1.9$ mm)

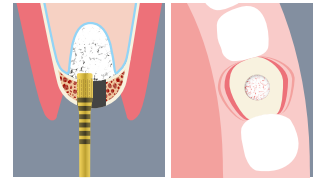

→ CUTTING ACTION

high efficiency bone osteoplasty

→ CLINICAL APPLICATION

bone remodelling and harvesting
of bone chips





→ CUTTING ACTION

osteoplasty

→ CLINICAL APPLICATION

bone osteotomy, remodelling and
removal of inflammatory tissue

→ OP3 – OP3A

principal osteoplasty insert

→ CUTTING ACTION

universal osteoplasty

→ CLINICAL APPLICATION

periodontal osteotomy, crown lengthening, bone chips harvesting, inflammatory tissue removal (cyst, etc.)



crown lengthening file

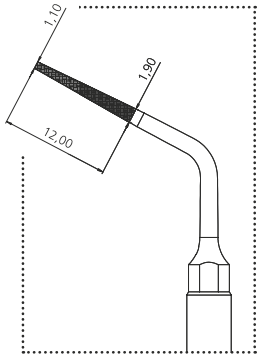

diamond grain size 126 μm

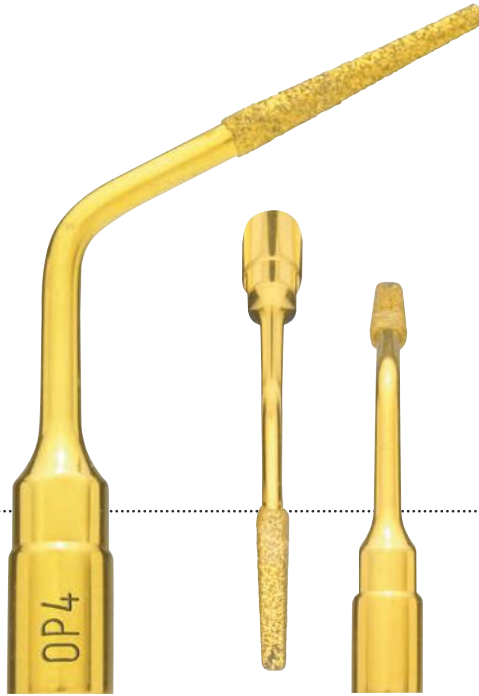

→ CUTTING ACTION
micro-osteoplasty

→ CLINICAL APPLICATION
interproximal osteoplasty
and root planing



→ OP5 – OP5A

root debridement insert

→ CUTTING ACTION

micro-osteoplasty

→ CLINICAL APPLICATION

root debridement and root planing during resective and regenerative periodontal surgery



diamond grain size 90 µm

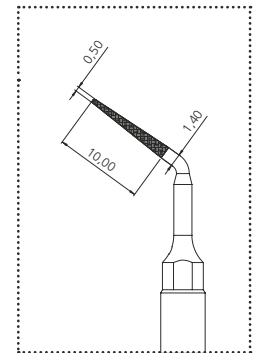

diamond grain size 30 µm



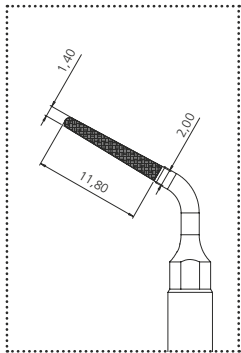

diamond grain size 126 µm



→ CUTTING ACTION

micro-root preparation

→ CLINICAL APPLICATION

root preparation in periodontal surgery



→ CUTTING ACTION

micro-osteoplasty

→ CLINICAL APPLICATION

peri-apical maxillary bone
osteotomy access, inflammatory
tissue removal



crown lengthening file / perio file

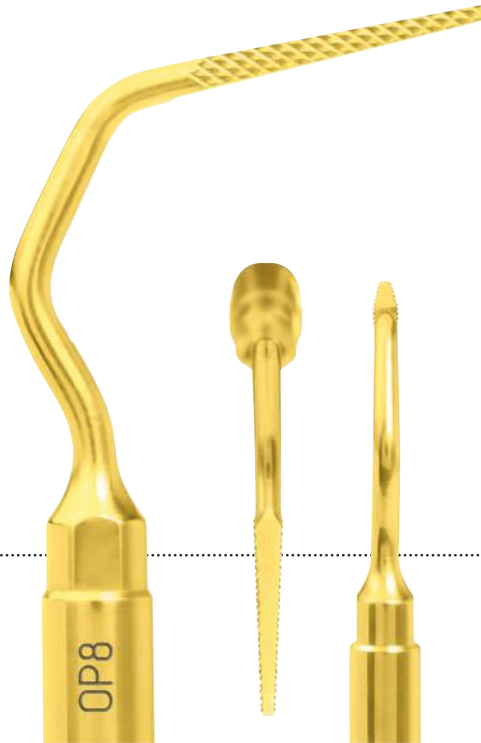
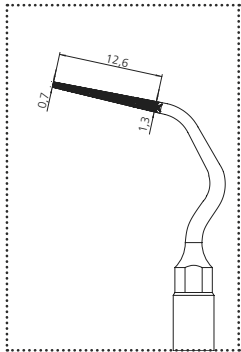

→ CUTTING ACTION
micro-osteoplasty

→ CLINICAL APPLICATION
Interproximal osteoplasty without
damaging adjacent root surfaces



*only available for PIEZOSURGERY® 3, PIEZOSURGERY® touch and PIEZOSURGERY® white

→ CUTTING ACTION

micro-osteoplasty

→ CLINICAL APPLICATION

Interproximal osteoplasty without
damaging adjacent root surfaces

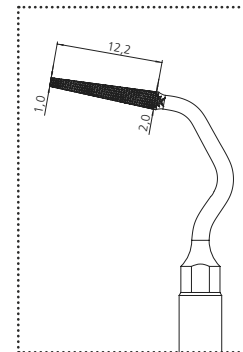
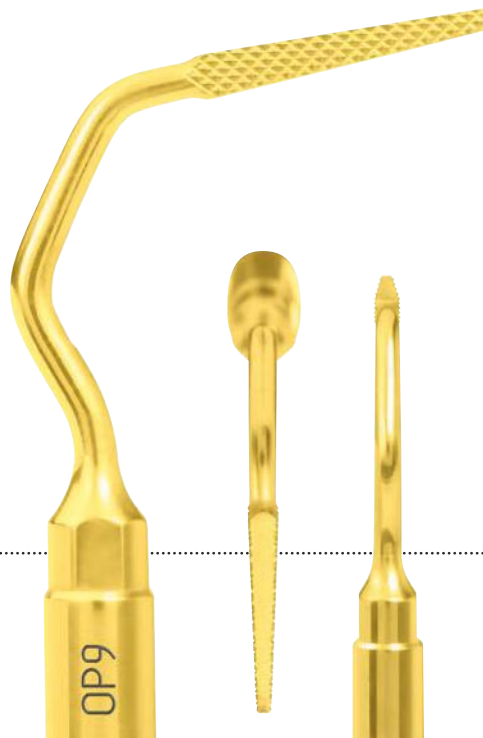

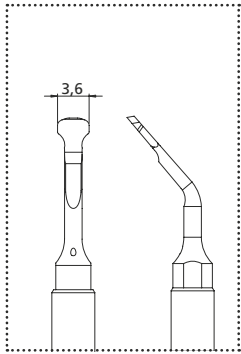

→ CUTTING ACTION

universal osteoplasty

→ CLINICAL APPLICATION

sinus vestibular wall consumption to gain the membrane access; bone chips harvesting, inflammatory tissue removal

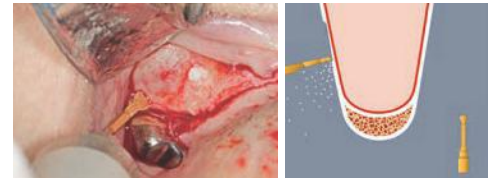

→ CUTTING ACTION

schneiderian membrane
separation from bony walls

→ CLINICAL APPLICATION

separation of the sinus membrane,
2 mm around the frame of bony window

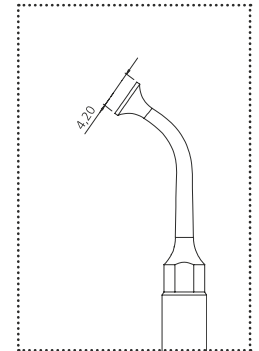

sinus membrane separator angled at 100°

→ EL2



→ CUTTING ACTION

non-cutting elevator of the
sinus membrane

→ CLINICAL APPLICATION

separation of the sinus membrane
in internal zones



→ CUTTING ACTION

non-cutting elevator of the
sinus membrane

→ CLINICAL APPLICATION

separation of the sinus membrane
in internal zones

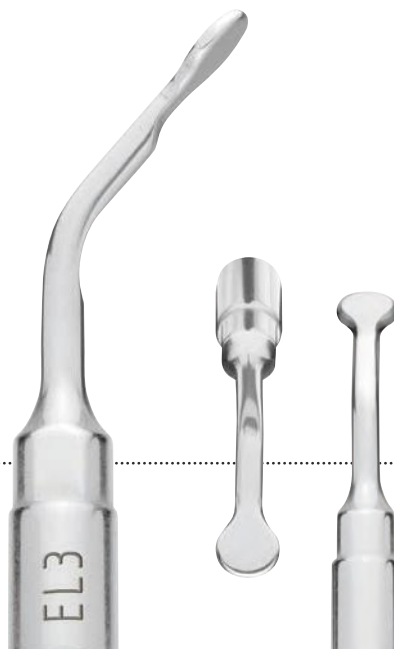

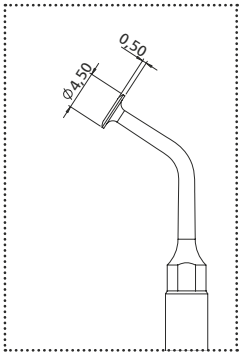

→ CUTTING ACTION
sinus membrane separator

→ CLINICAL APPLICATION
sinus membrane separation from
the bony window margins



→ CUTTING ACTION

elevator to cut Sharpey's fibers
from the endosteum

→ CLINICAL APPLICATION

sinus membrane elevation
from the sinus floor

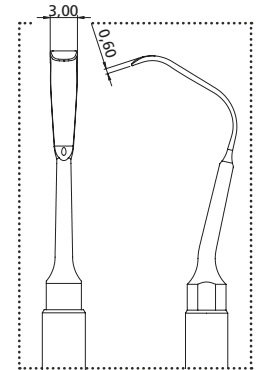

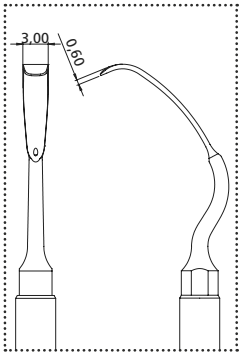

→ CUTTING ACTION

elevator to cut Sharpey's fibers from the endosteum

→ CLINICAL APPLICATION

sinus membrane elevation from the palatal wall



→ CUTTING ACTION
periosteum elevator

→ CLINICAL APPLICATION
subperiosteal preparation

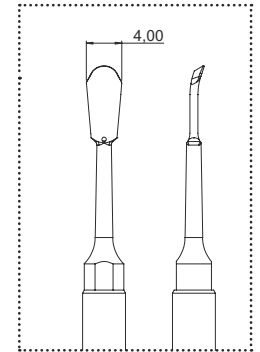

piezoelectric raspatory, 5 mm width

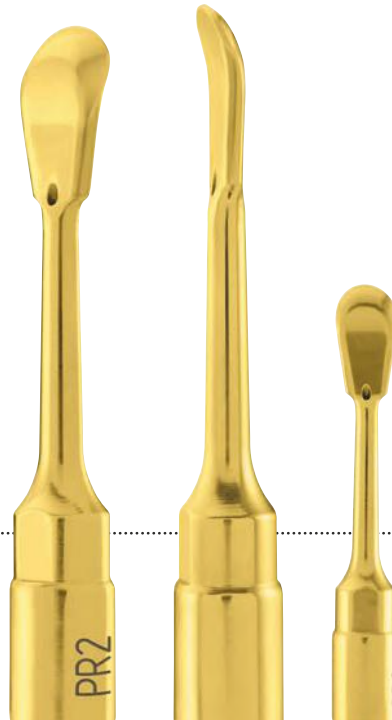
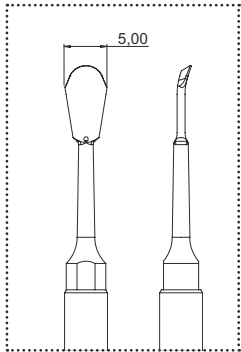

→ CUTTING ACTION
periosteum elevator

→ CLINICAL APPLICATION
subperiosteal preparation



→ CUTTING ACTION
efficient canal cleaning

→ CLINICAL APPLICATION
apical root debridement

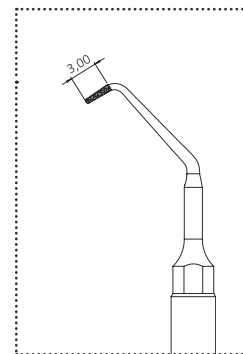
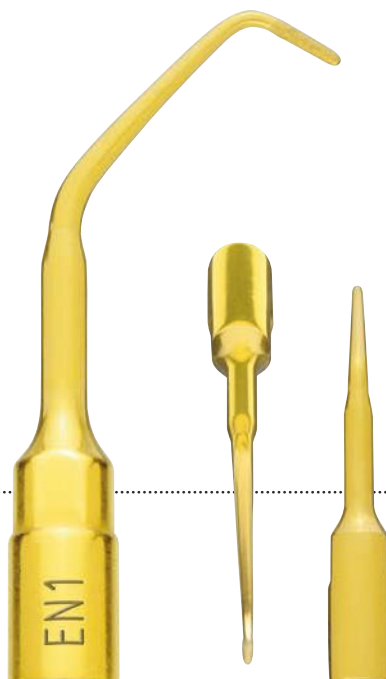

diamond grain size 30 µm

smooth endo apical debrider 3 mm

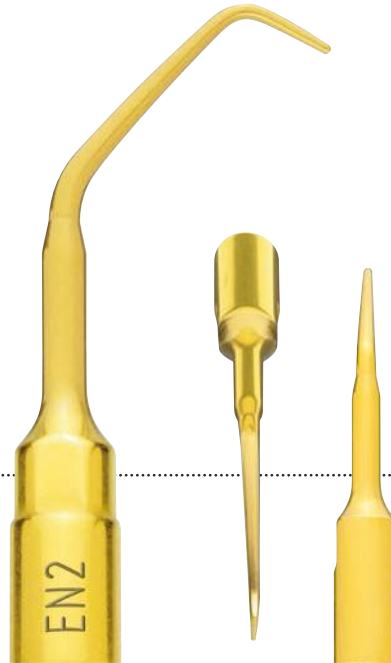

→ CUTTING ACTION

gentle canal cleaning

→ CLINICAL APPLICATION

gentle apical root debridement

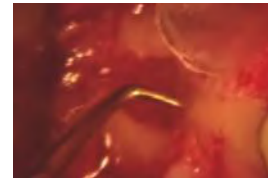

→ CUTTING ACTION
efficient canal cleaning

→ CLINICAL APPLICATION
apical root debridement

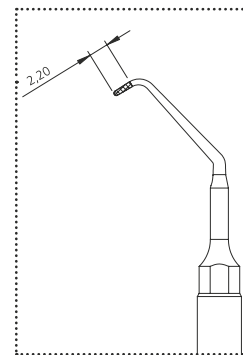

diamond grain size 30 μ m

smooth endo apical debrider 2.2 mm



→ CUTTING ACTION

gentle canal cleaning

→ CLINICAL APPLICATION

gentle apical root debridement

→ CUTTING ACTION
efficient canal cleaning

→ CLINICAL APPLICATION
apical root debridement

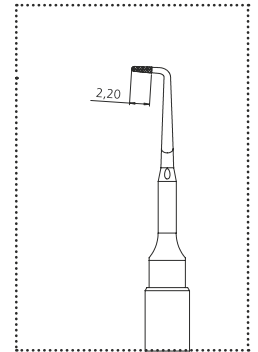
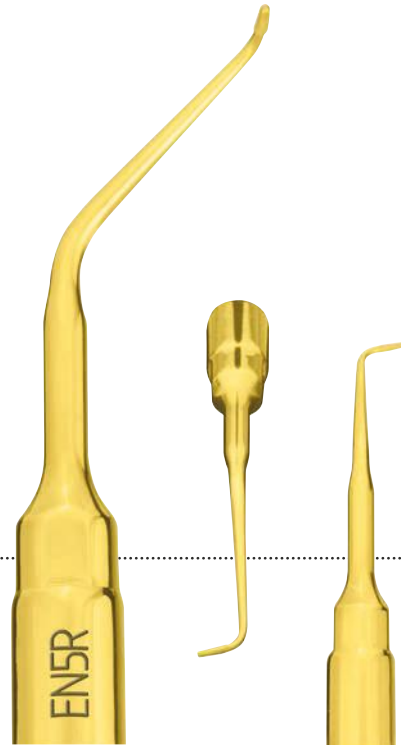

diamond grain size 30 µm

left angled, diamond-coated endo apical debrider 2.2 mm

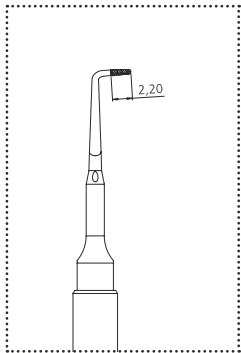

diamond grain size 30 μ m

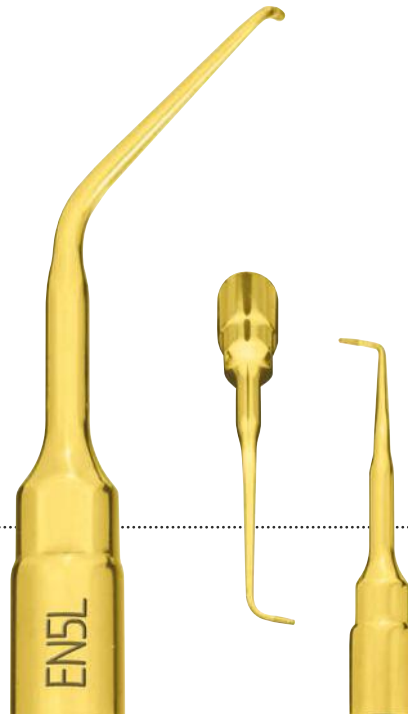

→ CUTTING ACTION

efficient canal cleaning

→ CLINICAL APPLICATION

apical root debridement

→ CUTTING ACTION
efficient canal cleaning

→ CLINICAL APPLICATION
apical root debridement

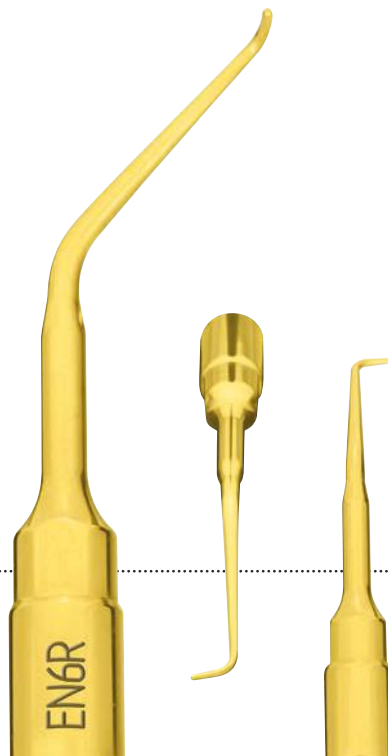

left angled, smooth endo apical debrider 2.2 mm

→ EN6L

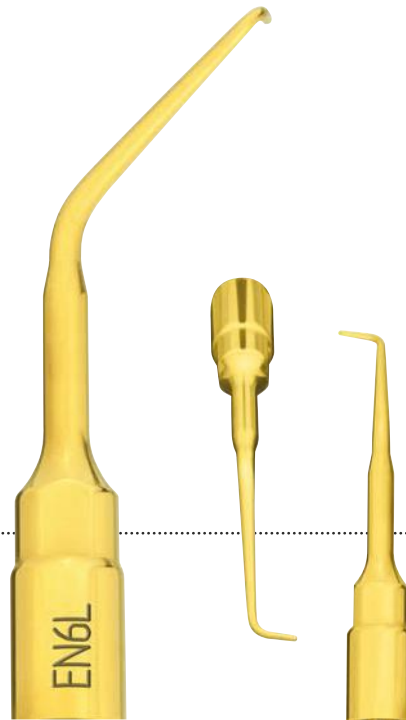

→ CUTTING ACTION

efficient canal cleaning

→ CLINICAL APPLICATION

apical root debridement

→ CUTTING ACTION

delicate osteotomy

→ CLINICAL APPLICATION

to cut off the ankylosis, root fraction techniques



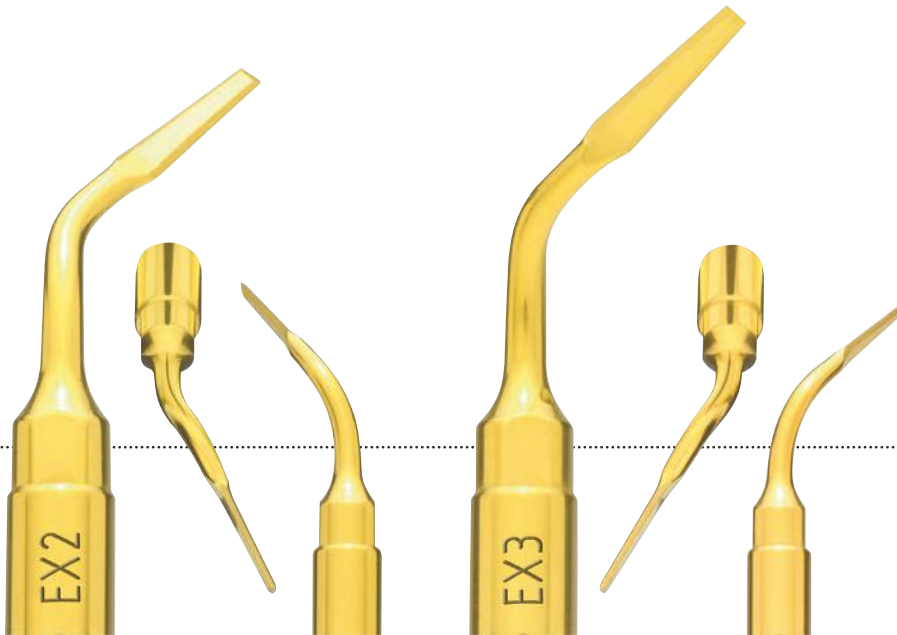

→ CUTTING ACTION
micrometric osteotomy

→ CLINICAL APPLICATION
analogue to EX1 in the posterior regions



PIEZOELECTRIC LEVERS

PIEZOELECTRIC INSTRUMENTS FOR THIRD MOLAR EXTRACTION

Mectron introduces the first piezoelectric lever to facilitate the luxation manoeuvre and sometimes even third molar root extraction, especially when ankylosed. This occurs when the manual force the operator exerts on the handpiece is added to the hammering action (typical of the Mectron PIEZOSURGERY®) which propagates from the lever into the deep periodontium. Additionally, proper use of the piezoelectric lever can significantly reduce operating time.

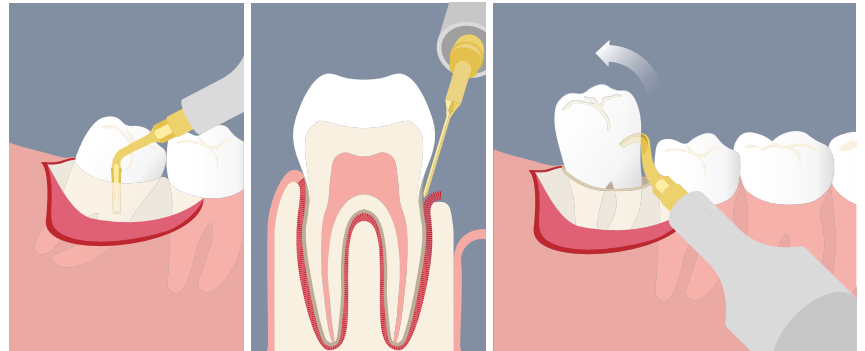

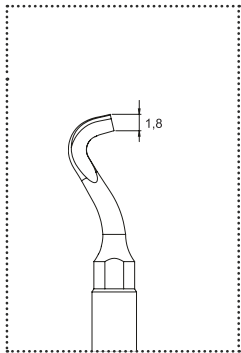

→ CUTTING ACTION

luxation and root extraction

→ CLINICAL APPLICATION

third molar extraction with piezoelectric technique



→ CUTTING ACTION

luxation and root extraction

→ CLINICAL APPLICATION

third molar extraction with piezoelectric technique

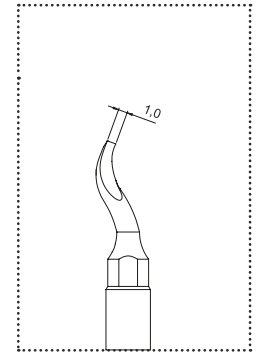

straight lever for alveolar debridement

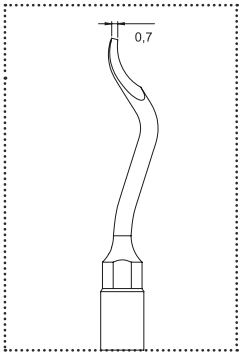

→ CUTTING ACTION

removal action of radicular fragments

→ CLINICAL APPLICATION

alveolar debridement from the extractive alveolus

EXP3-R — EXP3-L

explantations

→ CUTTING ACTION
peri-implant osteotomy

→ CLINICAL APPLICATION
explantations

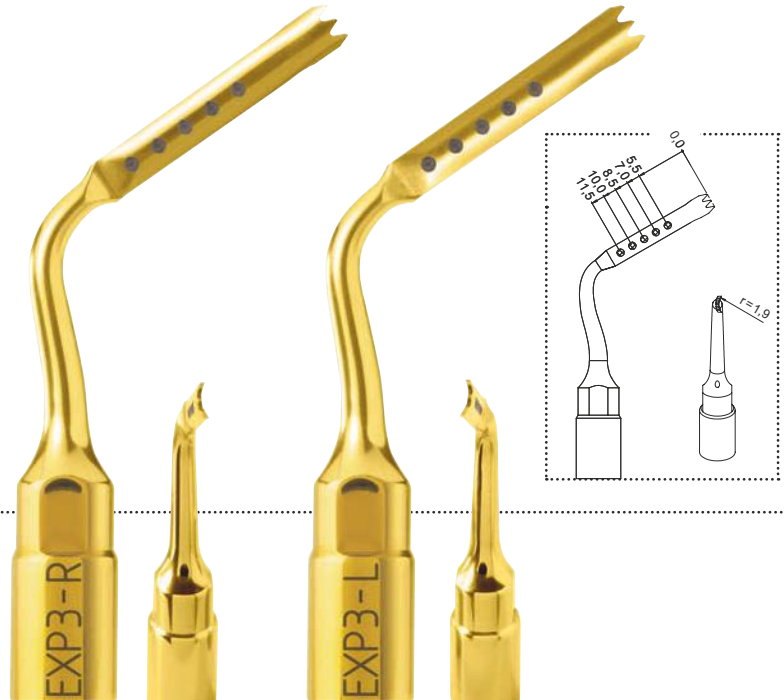

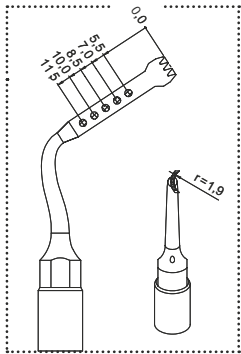

→ CUTTING ACTION
peri-implant osteotomy

→ CLINICAL APPLICATION
explantations



→ CUTTING ACTION

gentle scaling

→ CLINICAL APPLICATION

root scaling

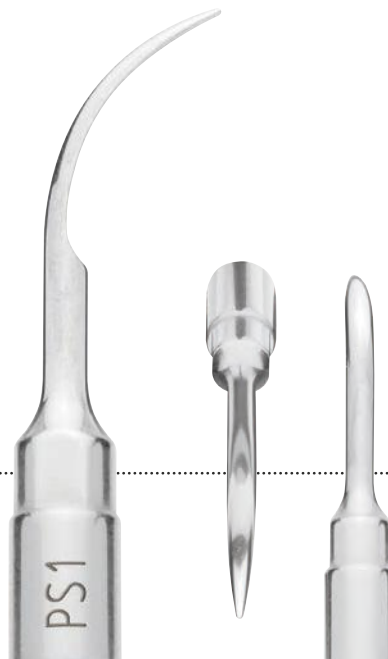

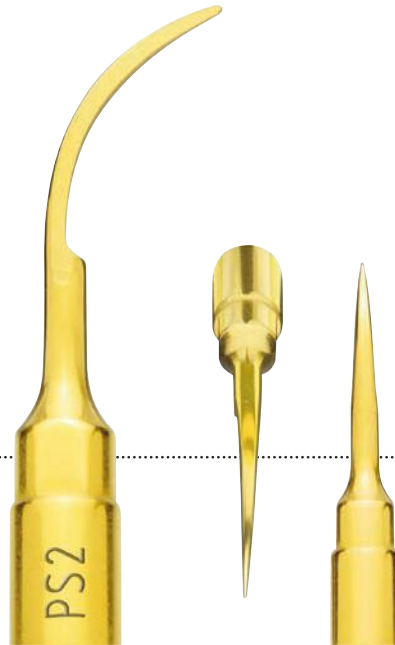

→ CUTTING ACTION

powerful scaling

→ CLINICAL APPLICATION

scaling and inflammatory tissue removal
fractured root apex extraction



→ CUTTING ACTION

gentle scaling

→ CLINICAL APPLICATION

root scaling



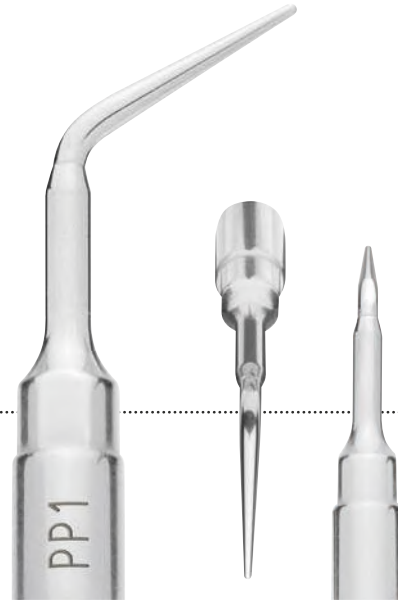

→ CUTTING ACTION
root surface micro-smoothing

→ CLINICAL APPLICATION
root planing

→ CUTTING ACTION

root surface micro-smoothing

→ CLINICAL APPLICATION

gentle subgingival concretions removal

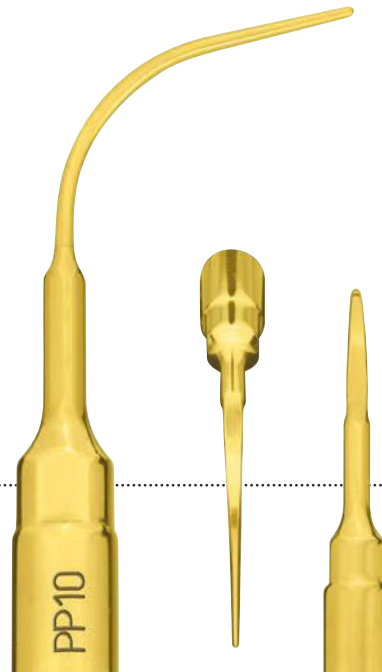

left and right angled, gentle perio anatomic insert

PP11 – PP12

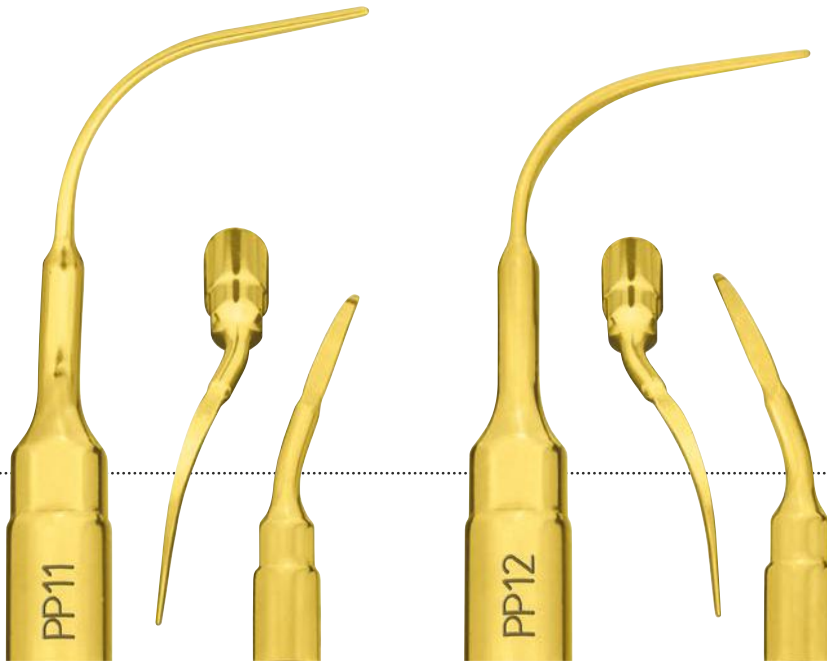

- **CUTTING ACTION**
root surface micro-smoothing
- **CLINICAL APPLICATION**
gentle subgingival concretions removal

→ CUTTING ACTION

gentle and safe cleaning action of the implant surface

→ CLINICAL APPLICATION

efficient and soft cleaning of implants and restorations



→ IMPLANT CLEANING SET P

The set consists of a tip holder ICP and 5 tips IC1

→ ICP
tip holder ICP

→ IC1
implant cleaning tip IC1 is made of PEEK, can be easily tightened without special tools and is fully autoclavable

preparation and finishing of subgingival margins → CROWN PREP TIPS



→ DYNAMOMETRIC
WRENCH K7



→ KEY AB1



→ CROWN PREP TIP
TF12D60

→ VERTICAL PREPARATION TECHNIQUE

→ LENGTH 10 MM → DIAMOND COATING

diameter	D90	D60
1.2 mm	TF12D90	TF12D60
1.6 mm	TF16D90	TF16D60



→ TIP HOLDER
DB2 WITH
CROWN PREP TIPS



→ CUTTING ACTION
micro-smoothing

→ CLINICAL APPLICATION
ultrasonic finishing of the cervical margin

→ CHAMFER TECHNIQUE

→ LENGTH 10 MM → DIAMOND COATING

diameter	D120	D90	D60
1.2 mm		TA12D90	TA12D60
1.4 mm	TA14D120	TA14D90	TA14D60
1.6 mm	TA16D120	TA16D90	TA16D60

→ CROWN PREP TIP
TA14D60



ENZYMEC

enzymatic detergent

- enzymatic solution for efficient removal of organic residue
- specifically dedicated to the “clean” function of all PIEZOSURGERY® devices
- works perfectly in ultrasonic cleaning tanks
- easy handling thanks to the dosage measuring cap

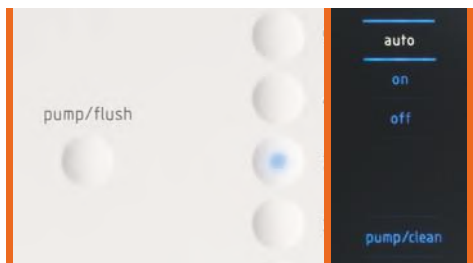

.....

.....

.....

→ PIEZOSURGERY® — MORE THAN 20 YEARS OF SUCCESSFUL SCIENTIFIC RESEARCH



→ METHOD PIEZOSURGERY®: EVIDENCE-BASED

With over 20 years of successful clinical research, the original PIEZOSURGERY® method is the only one supported by more than 250 clinical and scientific studies. An updated list of publications can be found at www.mectron.com. Scientific Abstracts are also available for download.

→ EXPERIENCE EDUCATION – MECTRON IS COMMITTED TO ENSURING YOU GET THE BEST KNOWLEDGE OF PIEZOSURGERY® METHOD.

PIEZOSURGERY® has caused a paradigm shift in osseous surgery and has become the new standard of care in oral and periodontal surgery. In addition to its revolutionary technology, its unique level of quality and its optimal ergonomic features, there is yet one more important factor to success with PIEZOSURGERY® technology: you.



→ EDUCATION.MECTRON.COM

We are happy to share with you our online education platform. It will allow you to attend free of charge our live and on-demand educational webinars and view our clinical video library. A fantastic possibility to take a deeper view on clinical opportunities helpful for your daily practice. Visit our mectron education platform and register to receive notifications about upcoming webinars.

→ WWW.MECTRON.COM/EDUCATION

On www.mectron.com we offer you even more seminars: In the section courses and workshops you will find different seminars on PIEZOSURGERY® in English. Please contact your mectron partner for the courses in your local language – you will find the contact address in the dealer list on our website.

SPARE PARTS



handpiece, complete with cord



handpiece holder with LED-handpiece



protection foils



PIEZOSURGERY® insert box



torque wrench K8

→ COMMON SPARE PARTS

→ ITEM/REFERENCE NUMBER	
surgical tray	04610004
torque wrench K8	02900109
irrigation set	03230006
PIEZOSURGERY® insert box with a tray holding 15 inserts	02900111
insert tray	02900037
PIEZOSURGERY® insert box with bone expander tray	02900107
PIEZOSURGERY® insert box with implant insert tray	02900108
bag support rod	01380002

→ WARNINGS

→ DIAMOND-COATED INSERTS

When the diamond chips wear out a reduction in cutting capacity and a consequent increase in temperature may occur. Use these inserts for a maximum of ten applications.

→ PIEZOSURGERY® *touch*

→ PIEZOSURGERY® *white*

→ ITEM/REFERENCE NUMBER	
LED-handpiece, complete with cord	03120134
handpiece, complete with cord (compatible with PS white)	03120217
handpiece holder	02900105
mobile handpiece holder	03110015
handpiece LED-cone	03020158
handpiece metal cone	03020171
set of 8 tubes for pump	02900104
bone grafting set (liquid flow rate reducer)	02900106
protection foils (pack of 10 sterile pieces)	03230012
footswitch (PS <i>touch</i>)	02900102
footswitch (PS <i>white</i>)	02900114
suitcase (PS <i>touch</i> and PS <i>white</i>)	04440006

→ CUTTING INSERTS

When the nitriding wears out the cutting edge loses efficiency and a re-sharpening is unadvisable due to its limited life-span.

→ PIEZOSURGERY® I, II AND 3

→ ITEM/REFERENCE NUMBER	
handpiece, complete with cord	03120023
handpiece holder (PSII + 3)	02900040
set of 8 tubes for pump (PSII + 3) (handpiece cord with metal connector)	02900039
set of 8 tubes for pump (PSII + 3) (handpiece cord with plastic connector)	02900104
tube-tube connector	00680027
footswitch (PSI + II)	02900020
footswitch (PS3)	02900078
peristaltic pump	03210006

→ MEMBRANE SEPARATORS

For a greater life-span it is recommended to use it on low power.
High power can be useful if there are residual bony edges to be removed.

REFERENCE NUMBERS

→ ITEM/REFERENCE NUMBER

basic set	01520001
osteotomy set	01520010
sinus lift lateral set	01520023
piezo lift set	01520024
manual piezo lift set	01520026
sinus lift set	01520002
implant prep set pro	01520011
extraction set	01520003
third molar extraction set	01520025
explantation set	01520021
resective perio set	01520022
retro surgical set	01520005
insert IM1S	03510019
PIN IM1	03740002
PIN IM1S	03740007
PIN 2-2.4	03740003
PIN 2-3	03740001
insert IM1 AL	03510010
PIN IM1 AL	03740004
PIN 2-2.4 AL	03740005
PIN 2-3 AL	03740006
insert IM2A	03510001

→ ITEM/REFERENCE NUMBER

insert IM2A-1S	03510015
insert IM2P	03510002
insert IM2P-1S	03510016
insert IM2.8A	03510025
insert IM2.8P	03510026
insert IM3A	03510003
insert IM3A-1S	03510017
insert IM3P	03510004
insert IM3P-1S	03510018
insert IM3.4A	03510027
insert IM3.4P	03510028
insert IM4A	03510005
insert IM4P	03510006
insert P2-3	03510020
insert P3-4	03510021
insert OT1	03370001
insert OT1A	03370008
insert OT2	03370002
insert OT4	03370004
insert OT5	03370005
insert OT5A	03370009
insert OT5B	03370010

→ ITEM/REFERENCE NUMBER

insert OT6	03370006
insert OT7	03370007
insert OT7A	03370011
insert OT7S-4	03370014
insert OT7S-3	03370015
insert OT7-20	03370017
insert OT8R	03370012
insert OT8L	03370013
insert OT9	03370016
insert OT11	03370019
insert OT12	03370020
insert OT12S	03370021
insert OT13	03370022
insert OT14	03370023
insert SLO-H	03370025
insert PL1	03370026
insert PL2	03370027
insert PL3	03370028
insert PL0419	03370030
insert PL0527	03370031
insert PL0631	03370032
insert PL0719	03370033

→ ITEM/REFERENCE NUMBER

insert OP1	03380001
insert OP2	03380002
insert OP3	03380003
insert OP3A	03380011
insert OP4	03380004
insert OP5	03380005
insert OP5A	03380012
insert OP6	03380006
insert OP7	03380007
insert OP8	03380008
insert OP9	03380009
insert SLC	03380013
insert EL1	03390001
insert EL2	03390002
insert EL3	03390003
insert SLS	03390006
insert SLE1	03390007
insert SLE2	03390008
insert PR1	03390004
insert PR2	03390005
insert EN1	02170001
insert EN2	02170002

→ ITEM/REFERENCE NUMBER

insert EN3	02170005
insert EN4	02170006
insert EN5R	02170007
insert EN5L	02170008
insert EN6R	02170009
insert EN6L	02170010
insert EX1	03400001
insert EX2	03400002
insert EX3	03400003
insert EXL1	03400008
insert EXL2	03400009
insert EXL3	03400010
insert EXP3-R	03400004
insert EXP3-L	03400005
insert EXP4-R	03400006
insert EXP4-L	03400007
insert PS1	03180001
insert PS2	03180003
insert PS6	03180005
insert PP1	03180002
insert PP10	03180006
insert PP11	03180007

→ ITEM/REFERENCE NUMBER

insert PP12	03180008
tipholder ICP	03570003
tip IC1 (5 pieces)	02900112
implant cleaning set P (ICP and 5 x IC1)	01520020
crown prep set PS (DB2, AB1 and K7)	02160010
tipholder DB2	03570002
key AB1	03580001
dynamometric wrench K7	02900081
crown prep tip TA12D60	03590001
crown prep tip TA14D60	03590002
crown prep tip TA16D60	03590003
crown prep tip TA12D90	03590004
crown prep tip TA14D90	03590005
crown prep tip TA16D90	03590006
crown prep tip TA14D120	03590007
crown prep tip TA16D120	03590008
crown prep tip TF12D60	03590010
crown prep tip TF16D60	03590011
crown prep tip TF12D90	03590012
crown prep tip TF16D90	03590013
Enzymec bottle (1 liter)	03900001
Enzymec 4-bottle pac (4 liter)	03900002

→ APPROPRIATE SETTINGS FOR THE INSERTS



→ PIEZOSURGERY® touch

→ PIEZOSURGERY® white

→ INSERT	FUNCTION
IMPLANT PREP	
IM1S	special*
IM1 AL	implant
IM2A	implant
IM2A-15	implant
IM2P	implant
IM2P-15	implant
IM2.8A	implant
IM2.8P	implant
IM3A	implant
IM3A -15	implant
IM3P	implant
IM3P-15	implant
IM3.4A	implant
IM3.4P	implant
IM4A	implant
IM4P	implant
P2-3	implant
P3-4	implant

→ INSERT	FUNCTION
OSTEOTOMY	
OT1	cancellous / cortical
OT1A	cancellous / cortical
OT2	cancellous / cortical
OT4	cancellous / cortical
OT5	cancellous / cortical
OT5A	cancellous / cortical
OT5B	cancellous / cortical
OT6	cancellous / cortical
OT7	cancellous / cortical
OT7A	cancellous / cortical
OT7S-3	special*
OT7S-4	special*
OT7-20	cancellous / cortical
OT8L	cancellous / cortical
OT8R	cancellous / cortical
OT9	cancellous / cortical
OT11	cancellous / cortical
OT12	cancellous / cortical
OT12S	special*
OT13	cancellous / cortical
OT14	cancellous / cortical
SLO-H	cancellous / cortical
PL1	cancellous / cortical
PL2	cancellous / cortical
PL3	cancellous / cortical
PL0419	cancellous / cortical
PL0527	cancellous / cortical
PL0631	cancellous / cortical
PL0719	cancellous / cortical
OSTEOPLASTY	
OP1	cancellous / cortical
OP2	cancellous / cortical
OP3	cancellous / cortical
OP3A	cancellous / cortical
OP4	cancellous / cortical
OP5	perio
OP5A	perio / special
OP6	perio
OP7	cancellous / cortical
OP8	perio / special
OP9	cancellous / cortical
SLC	cancellous / cortical

→ INSERT	FUNCTION
SINUS MEMBRANE ELEVATION	
EL1	endo*
EL2	endo*
EL3	endo*
SLS	special*
SLE1	special*
SLE2	special*
PERIOSTEUM	
PR1	cancellous / cortical
PR2	cancellous / cortical
ENDO RETRO	
EN1	endo*
EN2	endo*
EN3	endo*
EN4	endo*
EN5R	endo*
EN5L	endo*
EN6R	endo*
EN6L	endo*
EXTRACTION	
EX1	cancellous / cortical
EX2	cancellous / cortical
EX3	cancellous / cortical
EXL1	cortical
EXL2	cortical
EXL3	cortical
EXPLANTATION	
EXP3-R	special / cancellous / cortical
EXP3-L	special / cancellous / cortical
EXP4-R	special / cancellous / cortical
EXP4-L	special / cancellous / cortical
PERIO	
PP1	perio
PS1	perio
PS2	perio
PS6	perio
PP10	perio
PP11	perio
PP12	perio
IMPLANT CLEANING	
ICP + IC1	endo / perio
RESTORATIVE	
DB2	perio special

* Maximum power permitted



PIEZOSURGERY® 3

→ INSERT MODE POWER

IMPLANT PREP

	BONE	SPECIAL*
IM1S	BONE	SPECIAL*
IM1 AL	IMPL	IMPLANT
IM2A	IMPL	IMPLANT
IM2A-15	IMPL	IMPLANT
IM2P	IMPL	IMPLANT
IM2P-15	IMPL	IMPLANT
IM2.8A	IMPL	IMPLANT
IM2.8P	IMPL	IMPLANT
IM3A	IMPL	IMPLANT
IM3A -15	IMPL	IMPLANT
IM3P	IMPL	IMPLANT
IM3P-15	IMPL	IMPLANT
IM3.4A	IMPL	IMPLANT
IM3.4P	IMPL	IMPLANT
IM4A	IMPL	IMPLANT
IM4P	IMPL	IMPLANT
P2-3	IMPL	IMPLANT
P3-4	IMPL	IMPLANT

→ INSERT MODE POWER

OSTEOTOMY

	BONE	SPONGIOUS / CORTICAL
OT1A	BONE	SPONGIOUS / CORTICAL
OT2	BONE	SPONGIOUS / CORTICAL
OT4	BONE	SPONGIOUS / CORTICAL
OT5	BONE	SPONGIOUS / CORTICAL
OT5A	BONE	SPONGIOUS / CORTICAL
OT5B	BONE	SPONGIOUS / CORTICAL
OT6	BONE	SPONGIOUS / CORTICAL
OT7	BONE	SPONGIOUS / CORTICAL
OT7A	BONE	SPONGIOUS / CORTICAL
OT7S-3	BONE	SPECIAL*
OT7S-4	BONE	SPECIAL*
OT7-20	BONE	SPONGIOUS / CORTICAL
OT8L	BONE	SPONGIOUS / CORTICAL
OT8R	BONE	SPONGIOUS / CORTICAL
OT9	BONE	SPONGIOUS / CORTICAL
OT11	BONE	SPONGIOUS / CORTICAL
OT12	BONE	SPONGIOUS / CORTICAL
OT12S	BONE	SPECIAL*
OT13	BONE	SPONGIOUS / CORTICAL
OT14	BONE	SPONGIOUS / CORTICAL
SLO-H	BONE	SPONGIOUS / CORTICAL
PL1	BONE	SPONGIOUS / CORTICAL
PL2	BONE	SPONGIOUS / CORTICAL
PL3	BONE	SPONGIOUS / CORTICAL
PL0419	BONE	SPONGIOUS / CORTICAL
PL0527	BONE	SPONGIOUS / CORTICAL
PL0631	BONE	SPONGIOUS / CORTICAL
PL0719	BONE	SPONGIOUS / CORTICAL

OSTEOPLASTY

	BONE	SPONGIOUS / CORTICAL
OP1	BONE	SPONGIOUS / CORTICAL
OP2	BONE	SPONGIOUS / CORTICAL
OP3	BONE	SPONGIOUS / CORTICAL
OP3A	BONE	SPONGIOUS / CORTICAL
OP4	BONE	SPONGIOUS / CORTICAL
OP5	ROOT	PERIO
OP5A	ROOT	PERIO
	BONE	SPECIAL
OP6	ROOT	PERIO
OP7	BONE	SPONGIOUS / CORTICAL
OP8	ROOT	PERIO
	BONE	SPECIAL
OP9	BONE	SPONGIOUS / CORTICAL
SLC	BONE	SPONGIOUS / CORTICAL

→ INSERT MODE POWER

SINUS MEMBRANE ELEVATION

	ROOT	ENDO*
EL1	ROOT	ENDO*
EL2	ROOT	ENDO*
EL3	ROOT	ENDO*
SLS	BONE	SPECIAL*
SLE1	BONE	SPECIAL*
SLE2	BONE	SPECIAL*

PERIOSTEUM

	BONE	SPONGIOUS / CORTICAL
PR1	BONE	SPONGIOUS / CORTICAL
PR2	BONE	SPONGIOUS / CORTICAL

ENDO RETRO

	ROOT	ENDO*
EN1	ROOT	ENDO*
EN2	ROOT	ENDO*
EN3	ROOT	ENDO*
EN4	ROOT	ENDO*
EN5R	ROOT	ENDO*
EN5L	ROOT	ENDO*
EN6R	ROOT	ENDO*
EN6L	ROOT	ENDO*

EXTRACTION

	BONE	SPONGIOUS / CORTICAL
EX1	BONE	SPONGIOUS / CORTICAL
EX2	BONE	SPONGIOUS / CORTICAL
EX3	BONE	SPONGIOUS / CORTICAL
EXL1	BONE	CORTICAL
EXL2	BONE	CORTICAL
EXL3	BONE	CORTICAL

EXPLANTATION

	BONE	SPECIAL / SPONGIOUS / CORTICAL
EXP3-R	BONE	SPECIAL / SPONGIOUS / CORTICAL
EXP3-L	BONE	SPECIAL / SPONGIOUS / CORTICAL
EXP4-R	BONE	SPECIAL / SPONGIOUS / CORTICAL
EXP4-L	BONE	SPECIAL / SPONGIOUS / CORTICAL

PERIO

	ROOT	PERIO
PP1	ROOT	PERIO
PS1	ROOT	PERIO
PS2	ROOT	PERIO
PS6	ROOT	PERIO
PP10	ROOT	PERIO
PP11	ROOT	PERIO
PP12	ROOT	PERIO

IMPLANT CLEANING

	ROOT	ENDO / PERIO
ICP + IC1	ROOT	ENDO / PERIO

RESTORATIVE

	ROOT	PERIO
DB2	ROOT	PERIO
	BONE	SPECIAL

* Maximum power permitted

→ APPROPRIATE SETTINGS FOR THE INSERTS



→ PIEZOSURGERY® II

→ INSERT MODE POWER**

IMPLANT PREP

INSERT	MODE	POWER**
IM1S	BONE	SPECIAL*
IM1 AL	BONE	3 / 2 / 1
IM2A	BONE	3 / 2 / 1
IM2A-15	BONE	3 / 2 / 1
IM2P	BONE	3 / 2 / 1
IM2P-15	BONE	3 / 2 / 1
IM2.8A	BONE	3 / 2 / 1
IM2.8P	BONE	3 / 2 / 1
IM3A	BONE	3 / 2 / 1
IM3A -15	BONE	3 / 2 / 1
IM3P	BONE	3 / 2 / 1
IM3P-15	BONE	3 / 2 / 1
IM3.4A	BONE	3 / 2 / 1
IM3.4P	BONE	3 / 2 / 1
IM4A	BONE	3 / 2 / 1
IM4P	BONE	3 / 2 / 1
P2-3	BONE	3 / 2 / 1
P3-4	BONE	3 / 2 / 1

→ INSERT MODE POWER**

OSTEOTOMY

INSERT	MODE	POWER**
OT1	BONE	3 / 2 / 1
OT1A	BONE	3 / 2 / 1
OT2	BONE	3 / 2 / 1
OT4	BONE	3 / 2 / 1
OT5	BONE	3 / 2 / 1
OT5A	BONE	3 / 2 / 1
OT5B	BONE	3 / 2 / 1
OT6	BONE	3 / 2 / 1
OT7	BONE	3 / 2 / 1
OT7A	BONE	3 / 2 / 1
OT7S-3	BONE	SPECIAL*
OT7S-4	BONE	SPECIAL*
OT7-20	BONE	3 / 2 / 1
OT8L	BONE	3 / 2 / 1
OT8R	BONE	3 / 2 / 1
OT9	BONE	3 / 2 / 1
OT11	BONE	3 / 2 / 1
OT12	BONE	3 / 2 / 1
OT12S	BONE	SPECIAL*
OT13	BONE	3 / 2 / 1
OT14	BONE	3 / 2 / 1
SLO-H	BONE	3 / 2 / 1
PL1	BONE	3 / 2 / 1
PL2	BONE	3 / 2 / 1
PL3	BONE	3 / 2 / 1
PL0419	BONE	3 / 2 / 1
PL0527	BONE	3 / 2 / 1
PL0631	BONE	3 / 2 / 1
PL0719	BONE	3 / 2 / 1

OSTEOPLASTY

INSERT	MODE	POWER**
OP1	BONE	3 / 2 / 1
OP2	BONE	3 / 2 / 1
OP3	BONE	3 / 2 / 1
OP3A	BONE	3 / 2 / 1
OP4	BONE	3 / 2 / 1
OP5	ROOT	PERIO
OP5A	ROOT	PERIO
	BONE	SPECIAL
OP6	ROOT	PERIO
OP7	BONE	3 / 2 / 1
OP9	BONE	3 / 2 / 1
SLC	BONE	3 / 2 / 1

→ INSERT MODE POWER**

SINUS MEMBRANE ELEVATION

INSERT	MODE	POWER**
EL1	ROOT	ENDO*
EL2	ROOT	ENDO*
EL3	ROOT	ENDO*
SLS	BONE	SPECIAL 1
SLE1	BONE	SPECIAL 1
SLE2	BONE	SPECIAL 1

PERIOSTEUM

INSERT	MODE	POWER**
PR1	BONE	3 / 2 / 1
PR2	BONE	3 / 2 / 1

ENDO RETRO

INSERT	MODE	POWER**
EN1	ROOT	ENDO*
EN2	ROOT	ENDO*
EN3	ROOT	ENDO*
EN4	ROOT	ENDO*
EN5R	ROOT	ENDO*
EN5L	ROOT	ENDO*
EN6R	ROOT	ENDO*
EN6L	ROOT	ENDO*

EXTRACTION

INSERT	MODE	POWER**
EX1	BONE	3 / 2 / 1
EX2	BONE	3 / 2 / 1
EX3	BONE	3 / 2 / 1
EXL1	BONE	1
EXL2	BONE	1
EXL3	BONE	1

EXPLANTATION

INSERT	MODE	POWER**
EXP3-R	BONE	SPECIAL / 3 / 2 / 1
EXP3-L	BONE	SPECIAL / 3 / 2 / 1
EXP4-R	BONE	SPECIAL / 3 / 2 / 1
EXP4-L	BONE	SPECIAL / 3 / 2 / 1

PERIO

INSERT	MODE	POWER**
PP1	ROOT	PERIO
PS1	ROOT	PERIO
PS2	ROOT	PERIO
PS6	ROOT	PERIO
PP10	ROOT	PERIO
PP11	ROOT	PERIO
PP12	ROOT	PERIO

IMPLANT CLEANING

INSERT	MODE	POWER**
ICP + IC1	ROOT	ENDO / PERIO

RESTORATIVE

INSERT	MODE	POWER**
DB2	ROOT	PERIO
	BONE	SPECIAL

* Maximum power permitted

** Power: 1 = max 2 = med 3 = min



PIEZOSURGERY®

→ INSERT MODE POWER

IMPLANT PREP

→ INSERT	MODE	POWER
IM1S	BOOSTED	C
IM1 AL	BOOSTED	C
IM2A	BOOSTED	C
IM2A-15	BOOSTED	C
IM2P	BOOSTED	C
IM2P-15	BOOSTED	C
IM2.8A	BOOSTED	C
IM2.8P	BOOSTED	C
IM3A	BOOSTED	C
IM3A -15	BOOSTED	C
IM3P	BOOSTED	C
IM3P-15	BOOSTED	C
IM3.4A	BOOSTED	C
IM3.4P	BOOSTED	C
IM4A	BOOSTED	C
IM4P	BOOSTED	C
P2-3	BOOSTED	C
P3-4	BOOSTED	C

→ INSERT MODE POWER

OSTEOTOMY

OT1	BOOSTED	C
OT1A	BOOSTED	C
OT2	BOOSTED	C
OT4	BOOSTED	C
OT5	BOOSTED	C
OT5A	BOOSTED	C
OT5B	BOOSTED	C
OT6	BOOSTED	C
OT7	BOOSTED	C
OT7A	BOOSTED	C
OT7S-3	BOOSTED	C
OT7S-4	BOOSTED	C
OT7-20	BOOSTED	C
OT8L	BOOSTED	C
OT8R	BOOSTED	C
OT9	BOOSTED	C
OT11	BOOSTED	C
OT12	BOOSTED	C
OT12S	BOOSTED	C
OT13	BOOSTED	C
OT14	BOOSTED	C
SLO-H	BOOSTED	C
PL1	BOOSTED	C
PL2	BOOSTED	C
PL3	BOOSTED	C
PL0419	BOOSTED	C
PL0527	BOOSTED	C
PL0631	BOOSTED	C
PL0719	BOOSTED	C

OSTEOPLASTY

OP1	BOOSTED	C
OP2	BOOSTED	C
OP3	BOOSTED	C
OP3A	BOOSTED	C
OP4	BOOSTED	C
OP5	HIGH	2 - 3
OP5A	HIGH	2 - 3
OP6	ROOT	2 - 3
OP7	BOOSTED	C
OP9	BOOSTED	C
SLC	BOOSTED	C

→ INSERT MODE POWER

SINUS MEMBRANE ELEVATION

EL1	LOW	1
EL2	LOW	1
EL3	LOW	1
SLS	BOOSTED	C
SLE1	BOOSTED	C
SLE2	BOOSTED	C

PERIOSTEUM

PR1	BOOSTED	C
PR2	BOOSTED	C

ENDO RETRO

EN1	LOW	1
EN2	LOW	1
EN3	LOW	1
EN4	LOW	1
EN5R	LOW	1
EN5L	LOW	1
EN6R	LOW	1
EN6L	LOW	1

EXTRACTION

EX1	BOOSTED	C
EX2	BOOSTED	C
EX3	BOOSTED	C
EXL1	BOOSTED	C
EXL2	BOOSTED	C
EXL3	BOOSTED	C

EXPLANTATION

EXP3-R	BOOSTED	C
EXP3-L	BOOSTED	C
EXP4-R	BOOSTED	C
EXP4-L	BOOSTED	C

PERIO

PP1	HIGH	2 - 3
PS1	HIGH	2 - 3
PS2	HIGH	2 - 3
PS6	HIGH	2 - 3
PP10	HIGH	2 - 3
PP11	HIGH	2 - 3
PP12	HIGH	2 - 3

IMPLANT CLEANING

ICP + IC1	HIGH	2 - 3
	LOW	1

RESTORATIVE

DB2	HIGH	2 - 3
	BOOSTED	A

→ IMPLANT SITE PREPARATION SEQUENCE

→ PIEZOSURGERY® IMPLANT SITE PREPARATION INSERTS

→ IMPLANTS 3.2 – 3.3		→ IMPLANTS 3.7 – 3.8		→ IMPLANTS 4.0 – 4.1		→ IMPLANTS 4.8 – 5.0	
INSERT SEQUENCE	BONE QUALITY	INSERT SEQUENCE	BONE QUALITY	INSERT SEQUENCE	BONE QUALITY	INSERT SEQUENCE	BONE QUALITY
IM1S		IM1S		IM1S		IM1S	
IM2	L	IM2		IM2		IM2	
P2-3*		P2-3*		P2-3*		P2-3*	
IM2.8	M	IM2.8	L	IM3	L	IM3	
IM3	H	IM3	M	P3-4*		P3-4*	
		P3-4*		IM3.4	M	IM4	L M
		IM3.4	H	CORTICAL BONE TAP TOOL	H	CORTICAL BONE TAP TOOL	H

L	low bone density
M	medium bone density
H	hard bone density

* only crestal cortical

mectron s.p.a.,
via Loreto 15/A, 16042 Carasco (Ge), Italia,
tel +39 0185 35361, fax +39 0185 351374

→ www.mectron.com or mectron@mectron.com



© Copyright mectron S.p.A., Carasco, Italy

All rights reserved. Texts, pictures and graphics of mectron brochures are protected by copyright and other protection laws. Without written approval of mectron S.p.A. the contents may not be copied, distributed, changed or made available to third parties for commercial purposes.

The images shown are for illustration purposes only and may not be an exact representation of the product. Please consult product labels and manuals for indications, contraindications, hazards, warnings, cautions. Please contact your local sales representative for product availability.

The following products are registered under MDR 2017/745. For graphic reasons the styling of the product names might be different. The registered product names correspond as following:

- PIEZOSURGERY touch PIEZOSURGERY® *touch*
- PIEZOSURGERY white PIEZOSURGERY® *white*